



وحداتي

وحداتي
المستوى الثاني

يحتوي الكتاب على موضوعات
وحدات رياض الأطفال

إعداد: ربيعة خلفان الشاعر السويدي

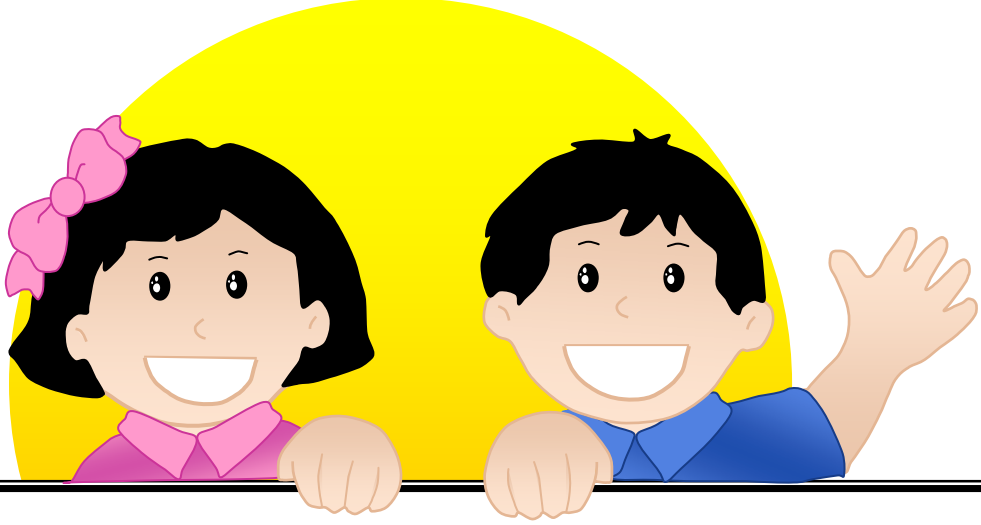

الاسم : _____
المدرسة : _____
المستوى الثاني : _____ العام الدراسي : _____

الكتاب غير مخصص للبيع

نشر على الموقع الإلكتروني

www.e-portal.ae البوابة التعليمية

إعداد: ربيعة خلفان الشاعر السويدي

e-p@e-portal.ae

دبي - الإمارات العربية المتحدة 2011 م



وحداتي

المستوى الثاني

- 3- وحدة أهلاً وسهلاً _____
- 9- وحدة أنا _____
- 15- وحدة العائلة _____
- 20- وحدة المسكن _____
- 26- وحدة رمضان _____
- 32- وحدة الملابس _____
- 37- وحدة اليوم الوطني _____
- 42- وحدة الطعام والشراب _____
- 49- وحدة الحيوانات _____
- 55- وحدة الصحراء _____
- 63- وحدة الحج _____
- 69- وحدة النباتات _____
- 74- وحدة الماء _____
- 80- وحدة المواصلات _____
- 88- وحدة السيرة النبوية _____
- 94- وحدة السياحة _____
- 99- وحدة الكتاب _____
- 105- وحدة البيئة _____
- 110- وحدة الفضاء _____
- 116- وحدة مع السلامة _____



وحدة

أهلاً وسهلاً



أهلاً وسهلاً



3

www.Cryp2Day.com

مذكرات جاهزة للطباعة

وحداتي

أرسم علامة X على السلوك الخاطئ.



أهلاً وسهلاً

الأركان التعليمية مختلفة، أصل كل ركن بما يحتويه.

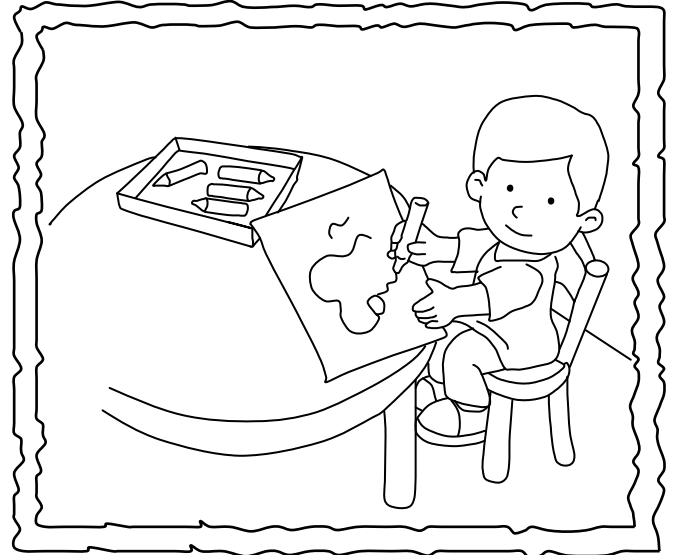
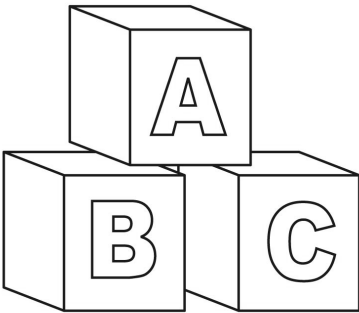
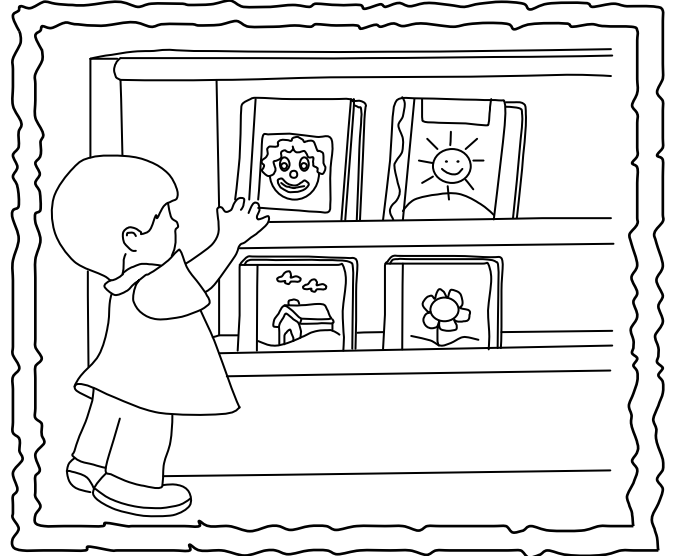
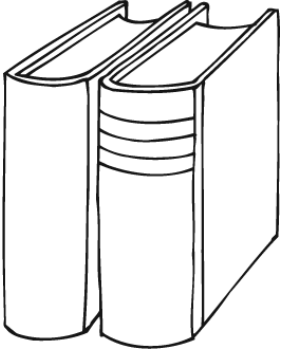
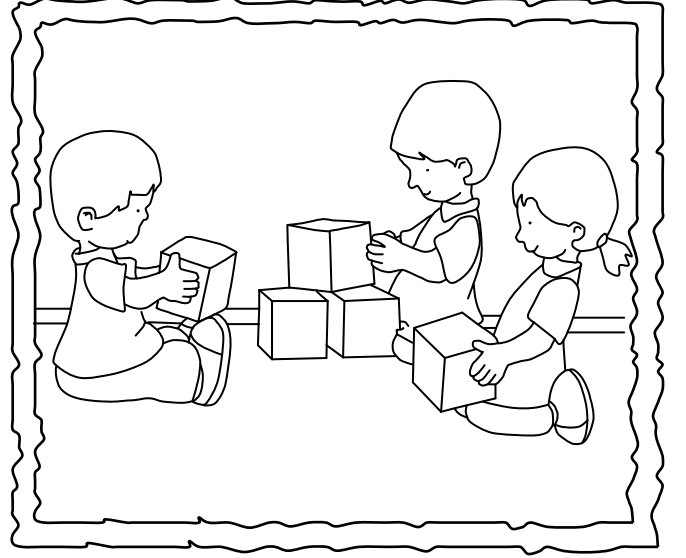
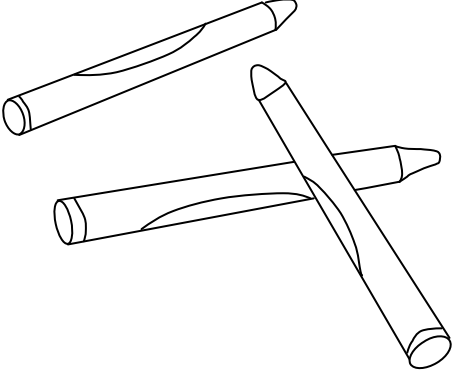

أخطط.

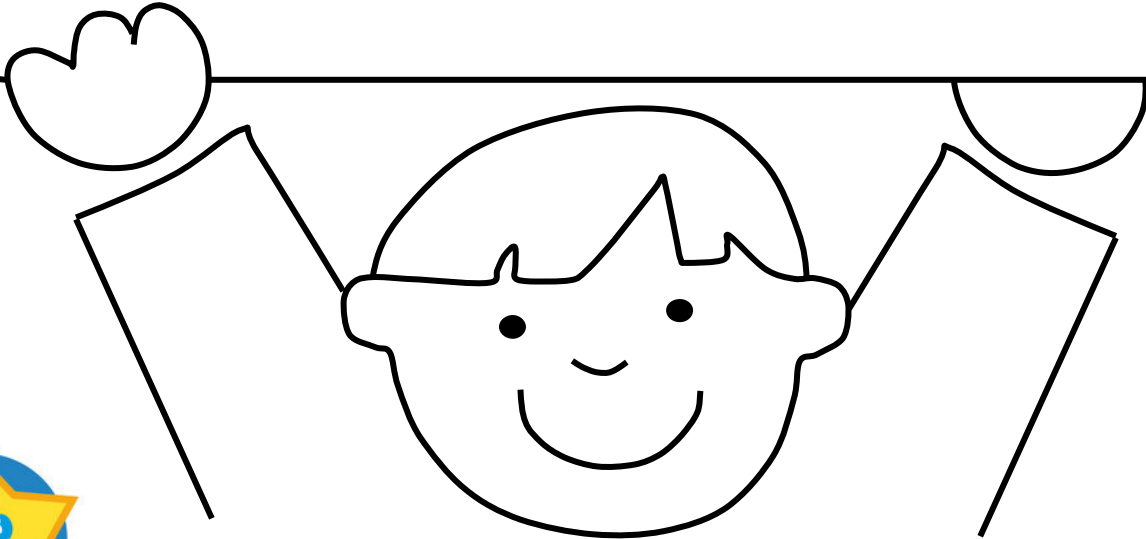
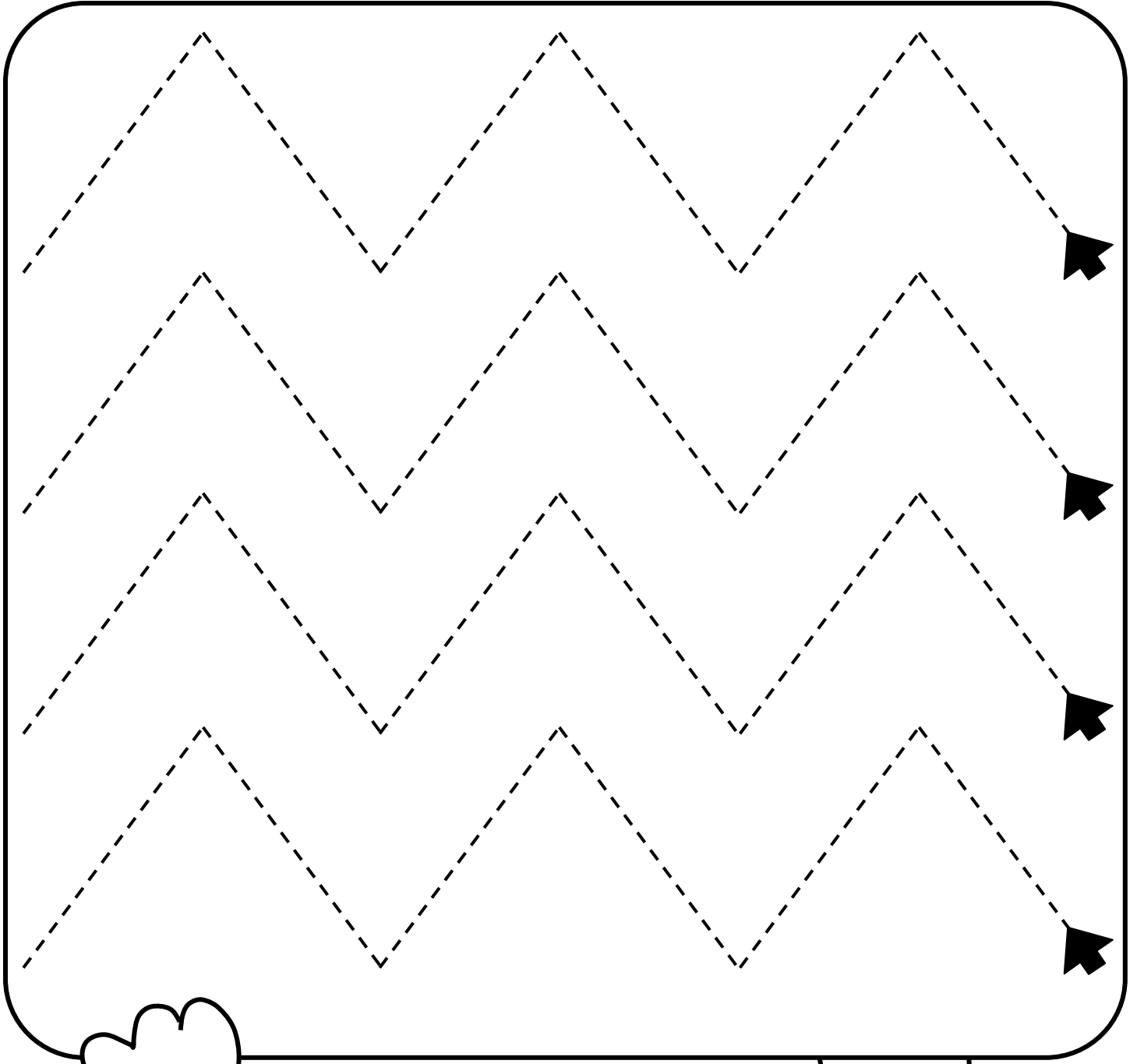

أهلاً وسهلاً

6

وحداتي



أخطط.

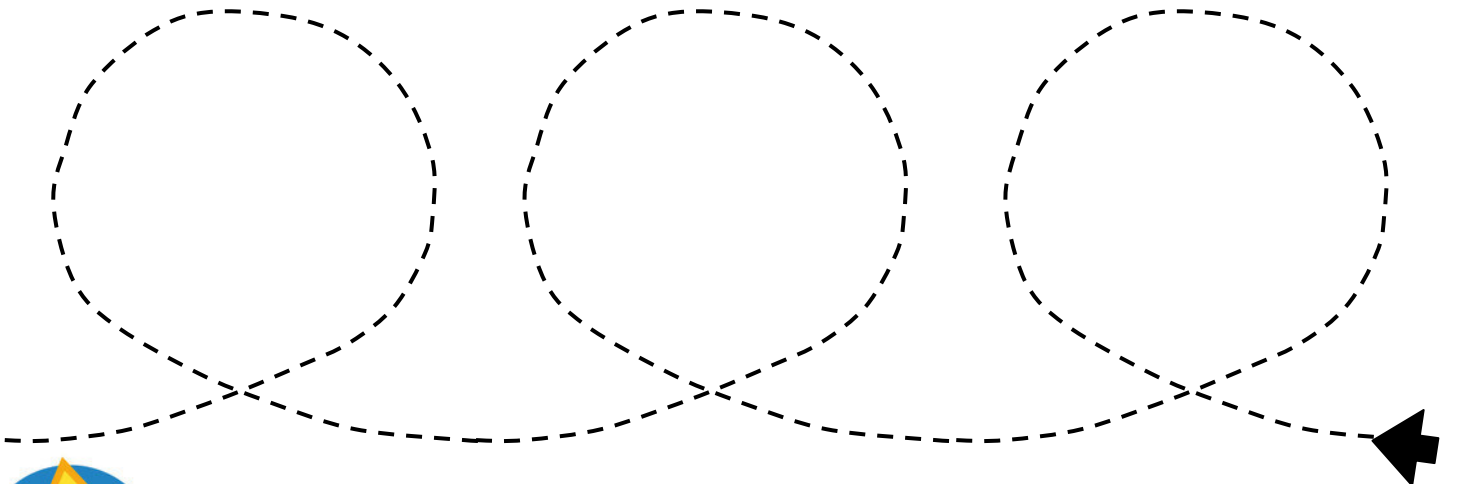
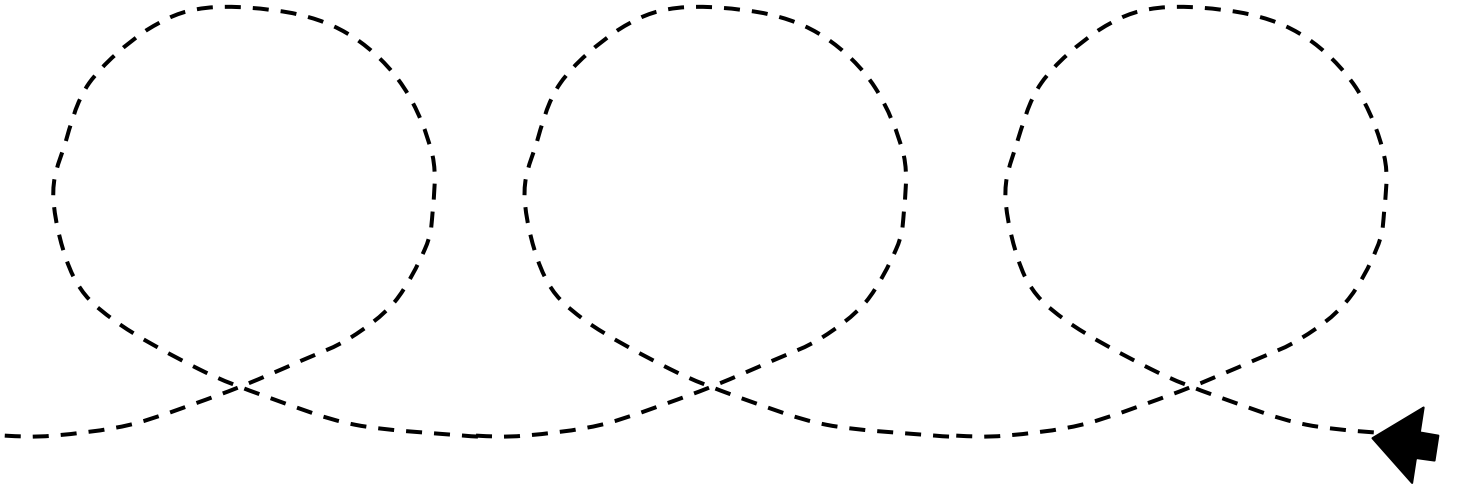
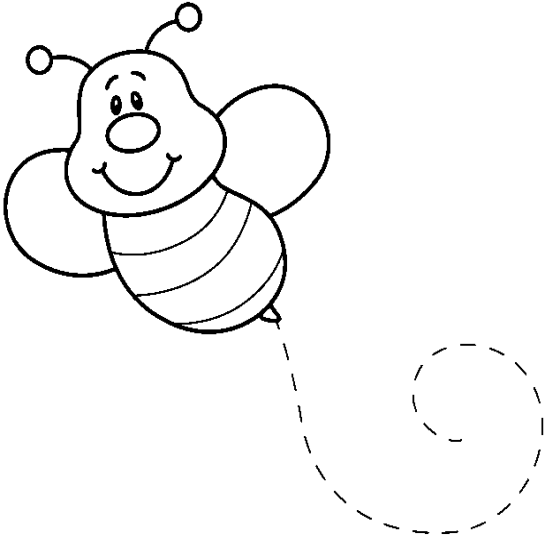

الاستئذان، أحوط ما يدل على الاستئذان، ألون.

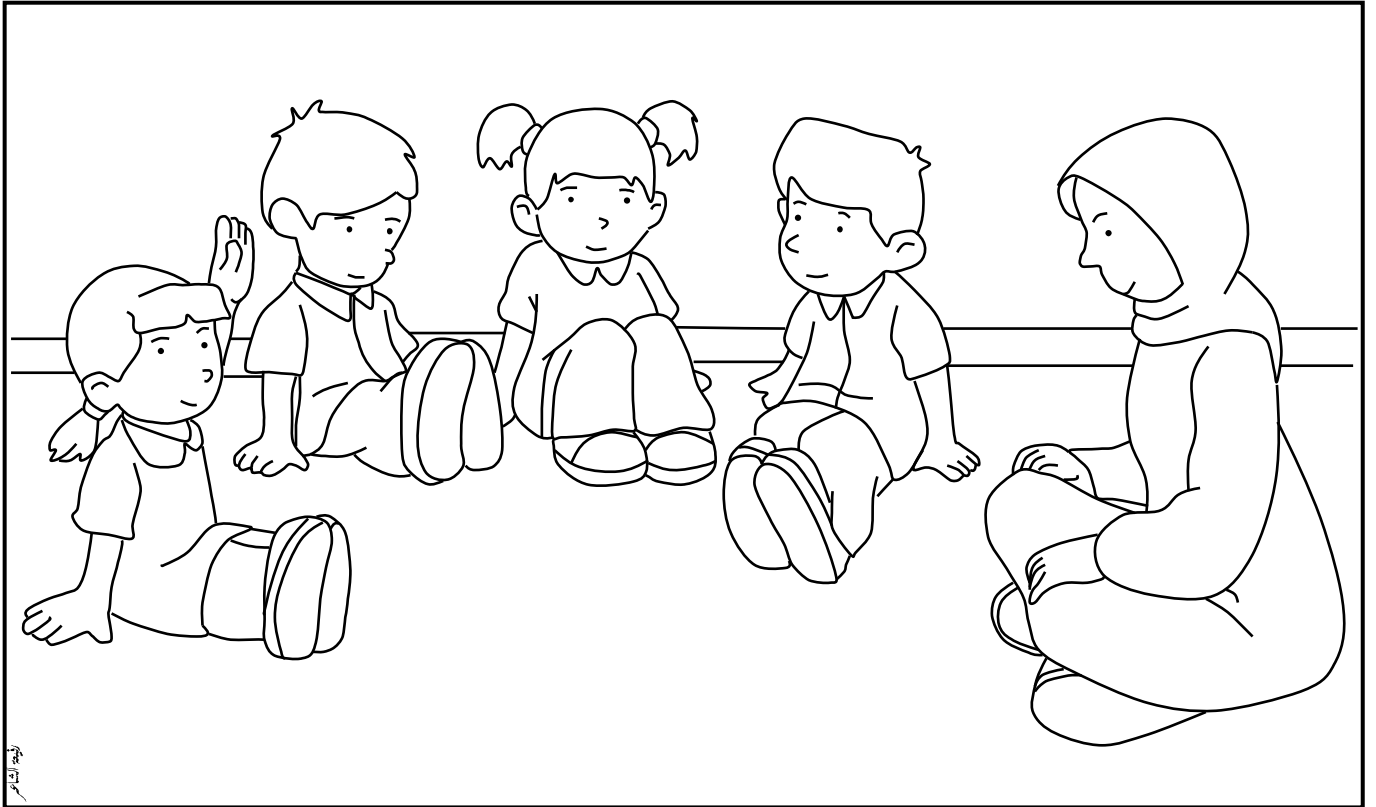
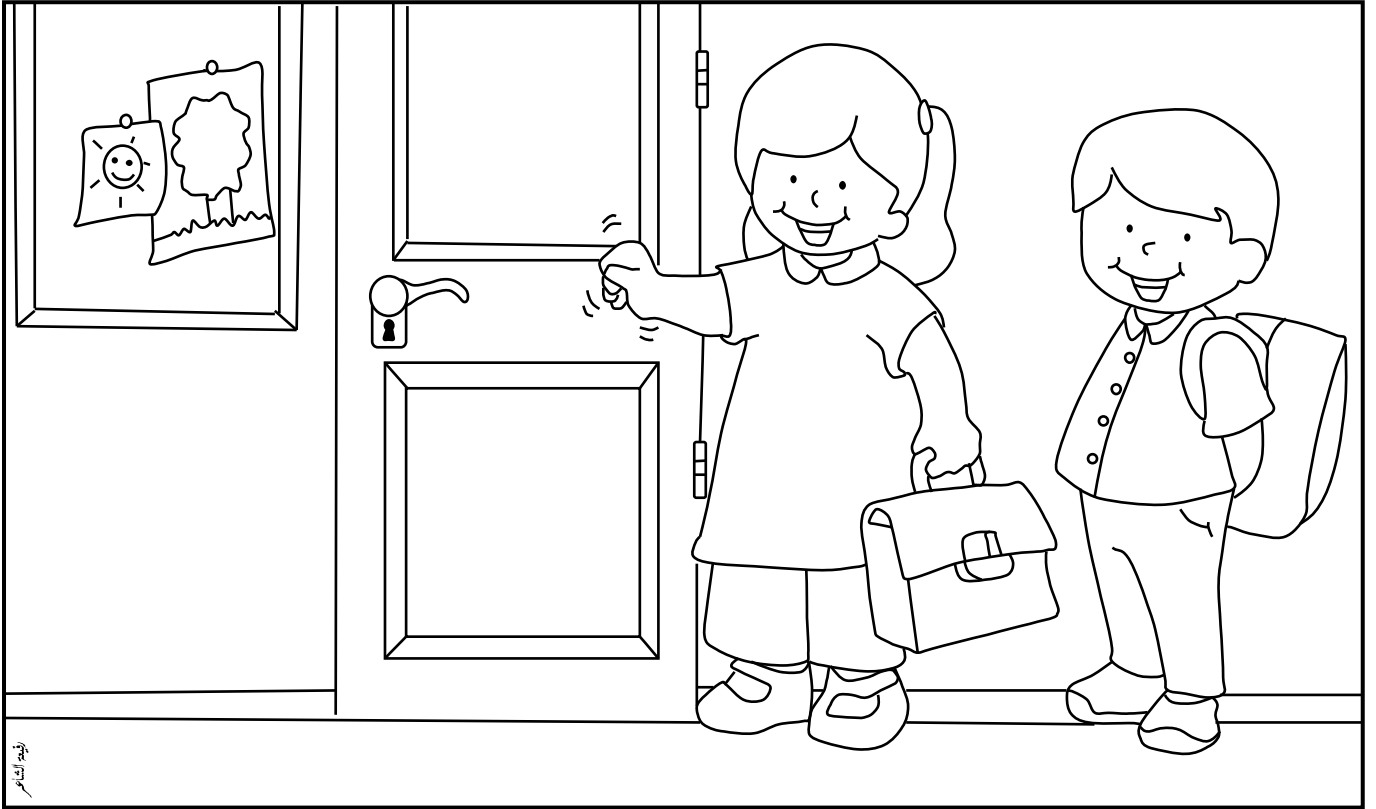

الاستئذان قبل الدخول، إلقاء تحية الإسلام.
الطفل يستأذن إذا أراد الخروج من غرفة التعلم للذهاب إلى الحمام. أذكر مواقف أخرى.





وحدة

أنا



أنا



أنا لي مشاعر ، مشاعرنا مختلفة ، أصل.

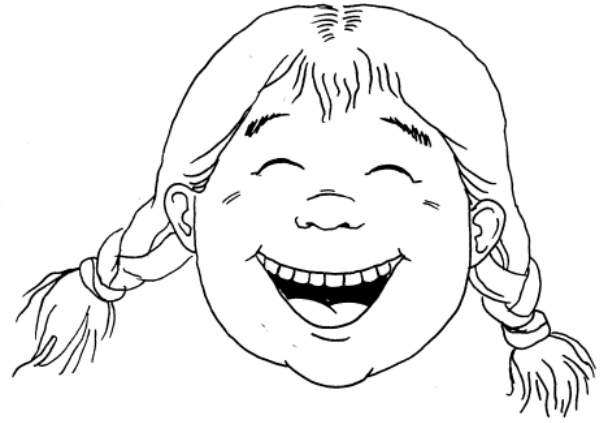
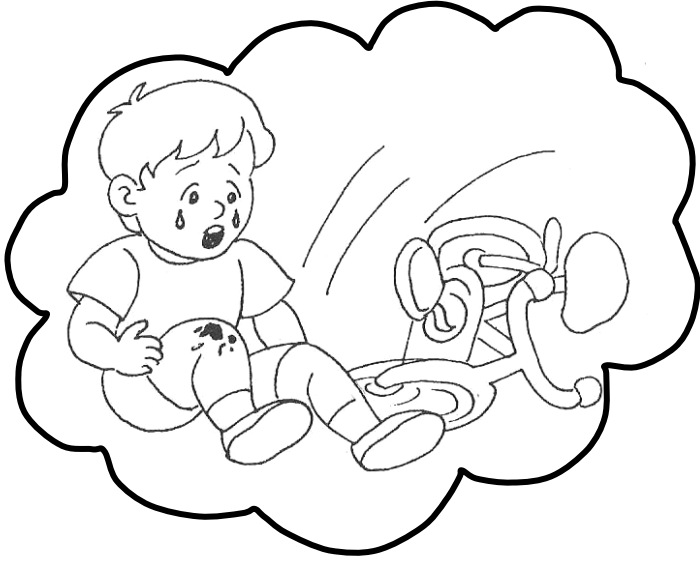

بواسطة أنفي أشم الكثير من الروائح، أحوط الروائح التي تعجبني.

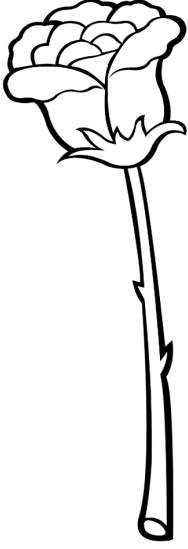

وردة

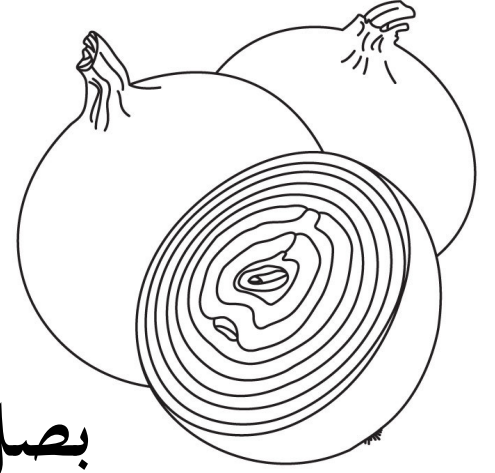

بصل

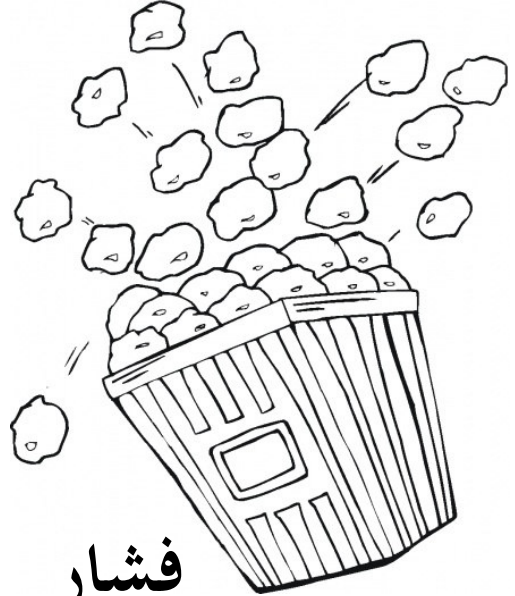

فشار



دخان

سلة المهملات

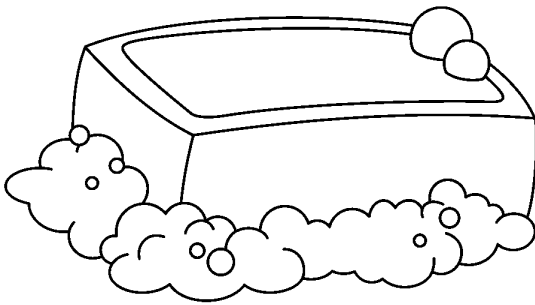

صابون



لي أذنان أسمع بهما، أحوط ما يمكنني سماع صوته.

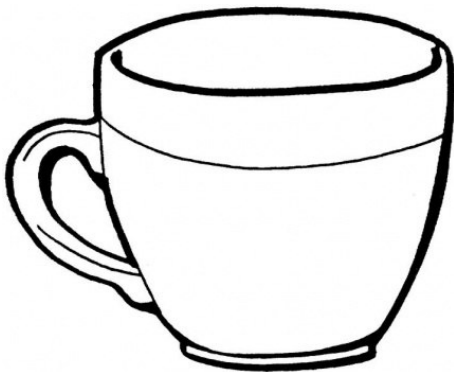
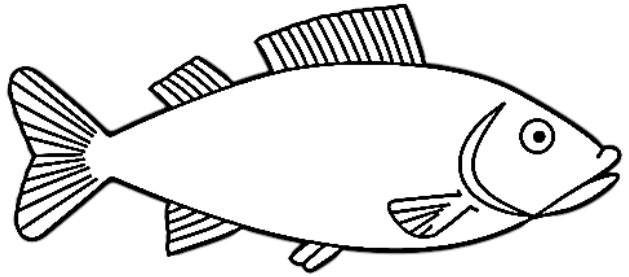
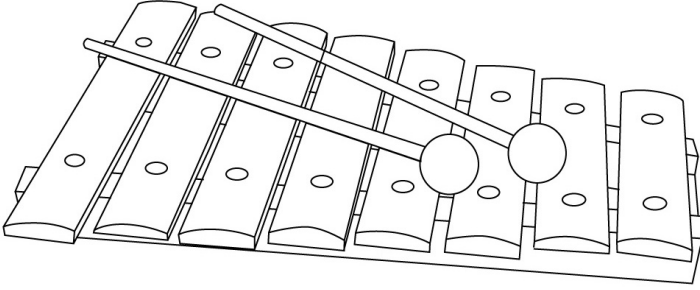

أشياء أستطيع حملها، وأشياء لا أستطيع حملها، ألون ما يمكنني حمله.

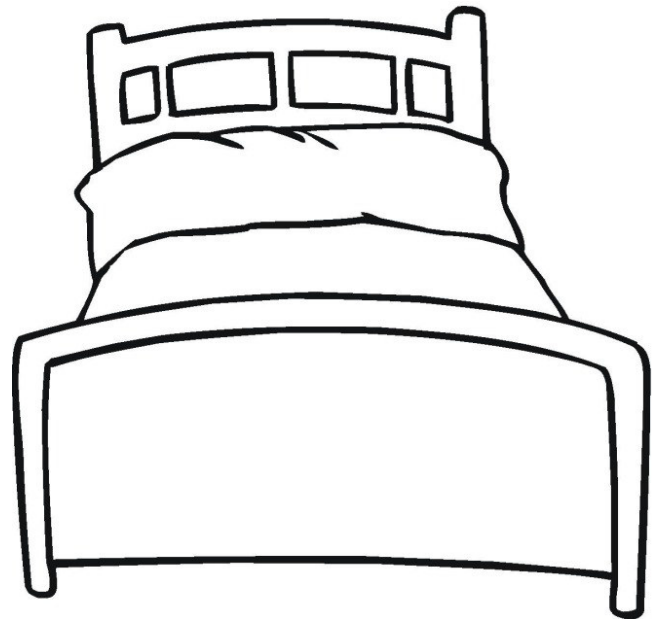
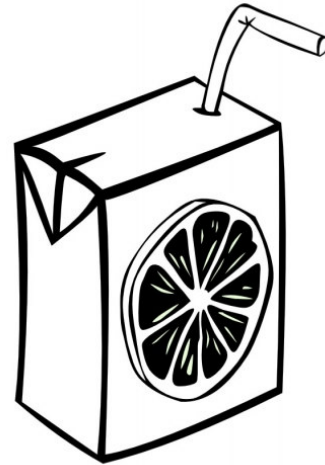
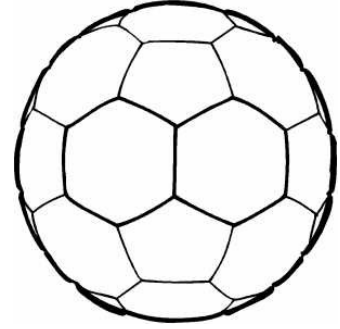
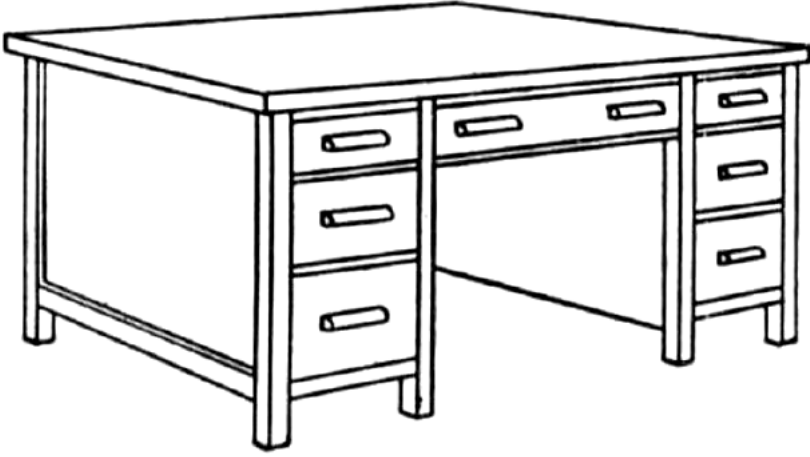

" طويل ، قصير " ألون الطويل بلون مختلف عن القصير .

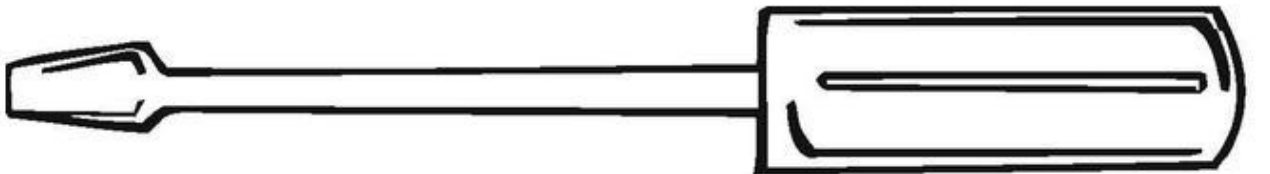
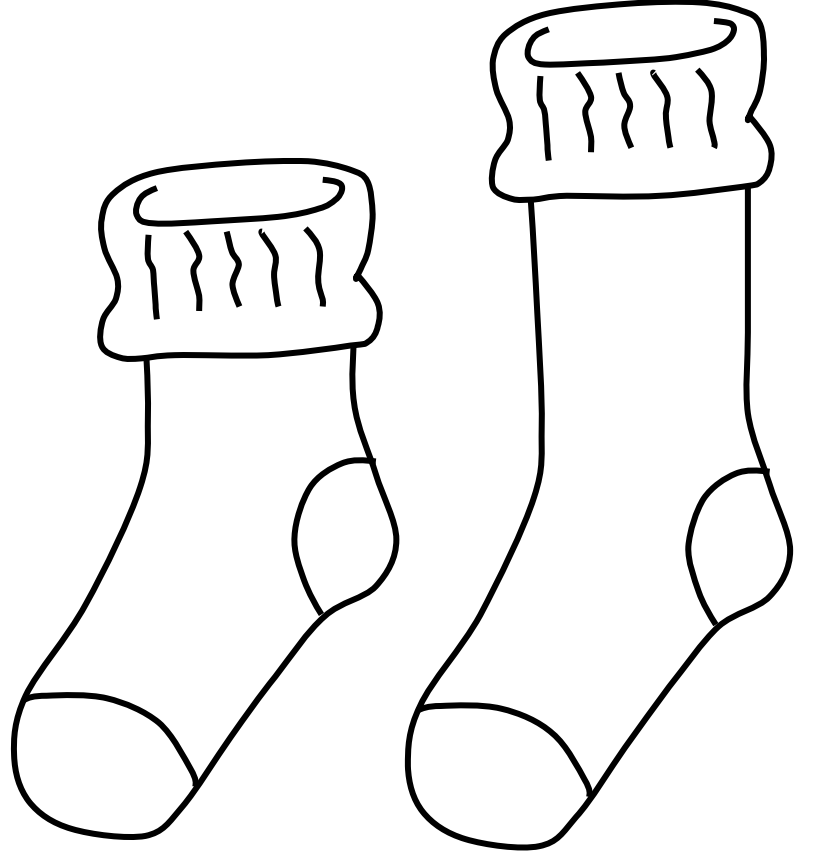
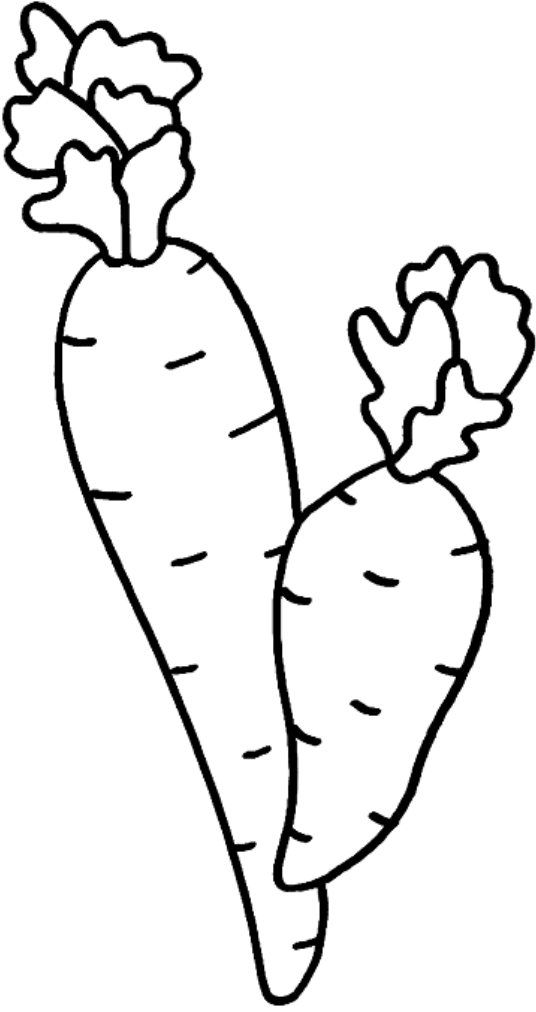



وحدة

العائلة



أفراد العائلة . أخطط على الكلمات المنقطة.

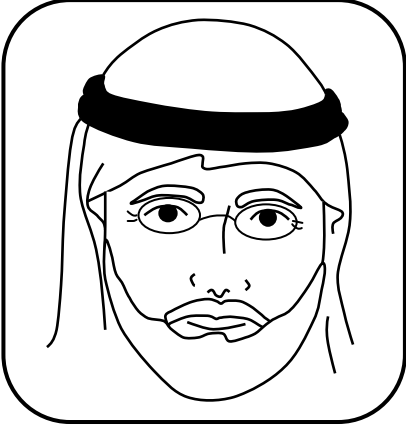

جدي



أبي



جدتي

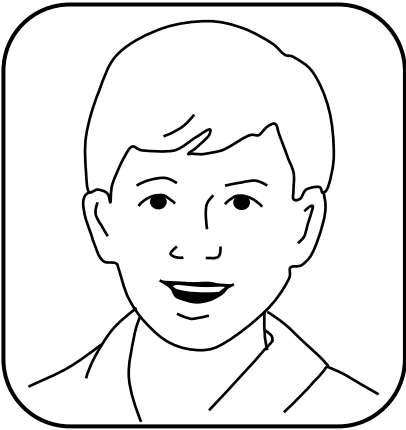

أخي

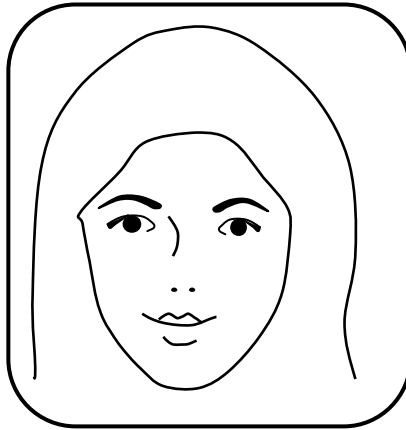

أمي

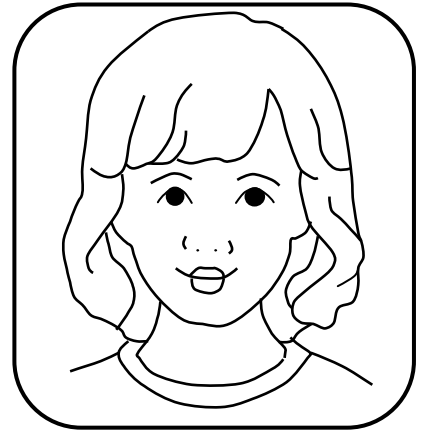

أختي



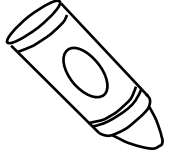

في العائلة ذكور وإناث ، ألّون.

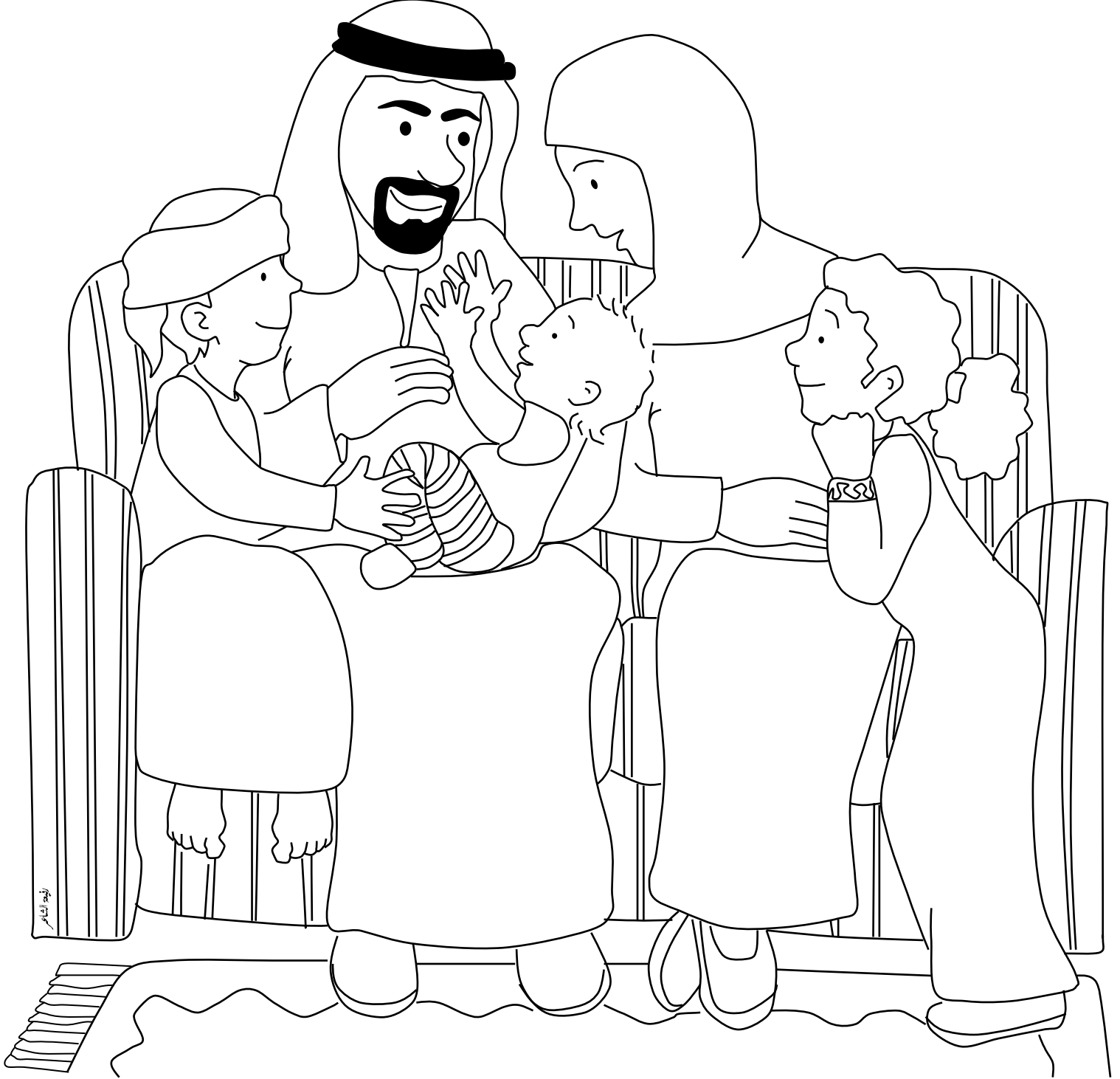

يتعرف الطفل علي الإناث والذكور في أفراد العائلة (أبي ، أمي ، أخي ، أختي ، أخي الرضيع)
من ثم يلوّن الطالب صور الذكور والطالبة صور الإناث أو كما تطلب منه المعلمة.



أصنّف كبير، صغير، متوسط. ألّون ما حجمه كبير باللون الأحمر وما حجمه صغير باللون الأصفر، وأحوّط ما حجمه متوسط.

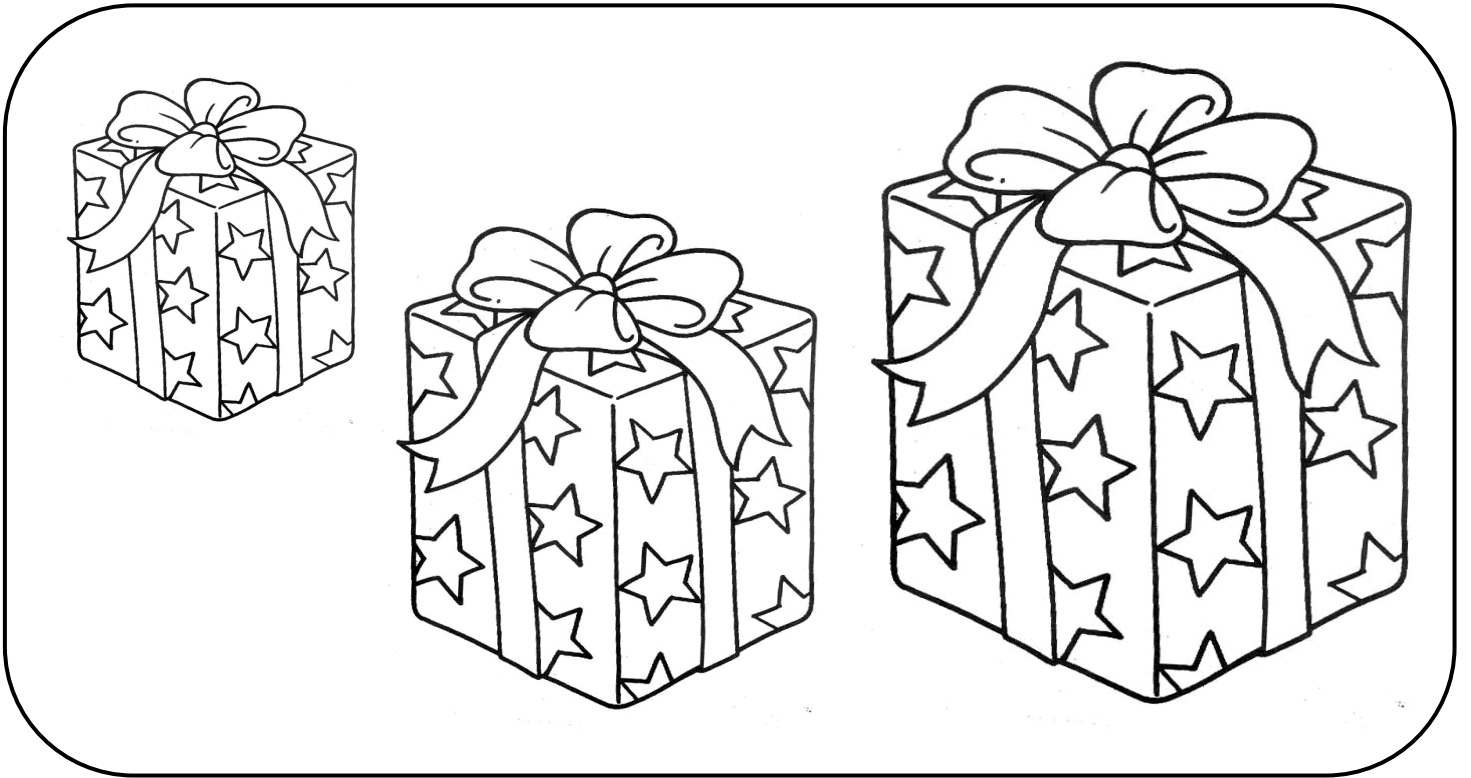
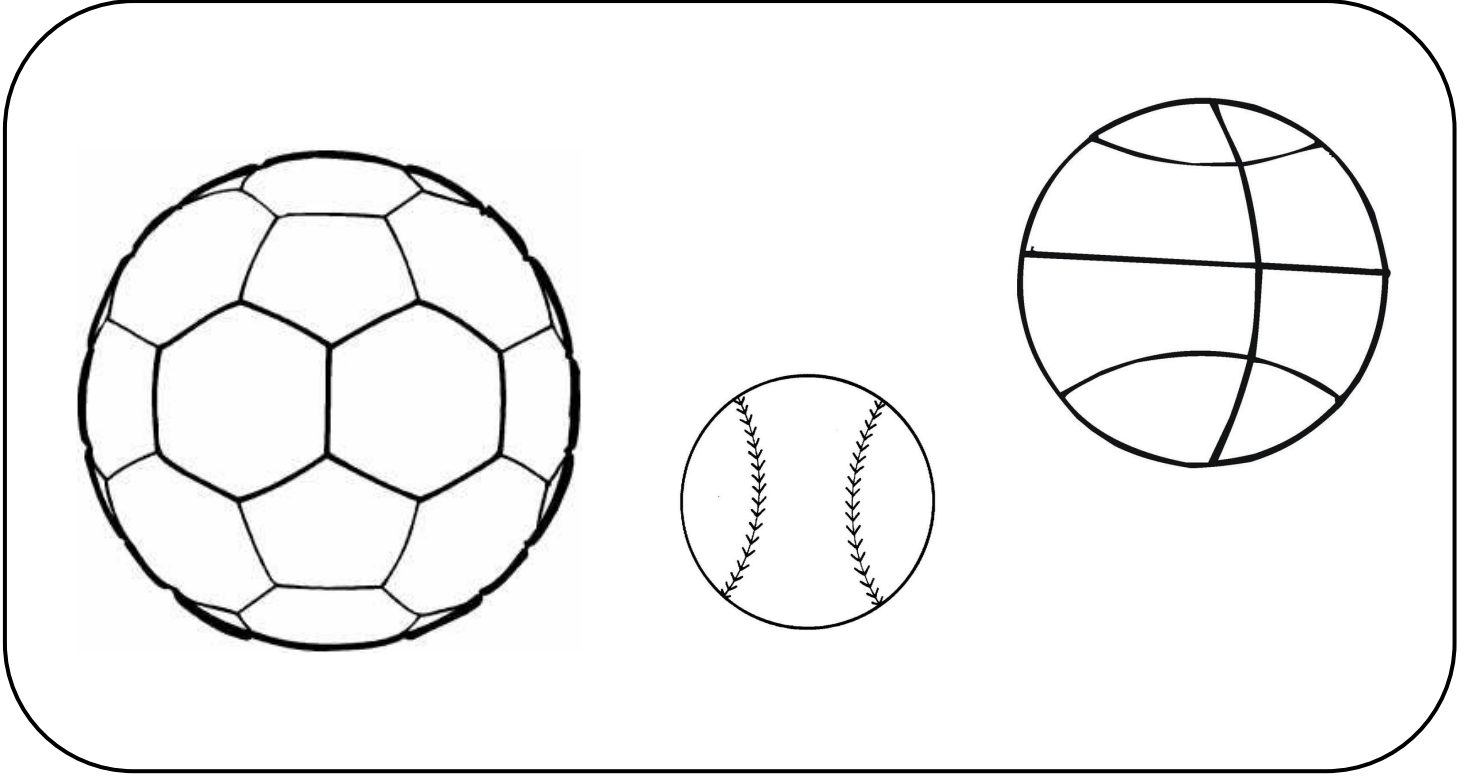

" فوق ، تحت " أرسم ○ على ما هو فوق وأرسم ✕ على ما هو تحت .

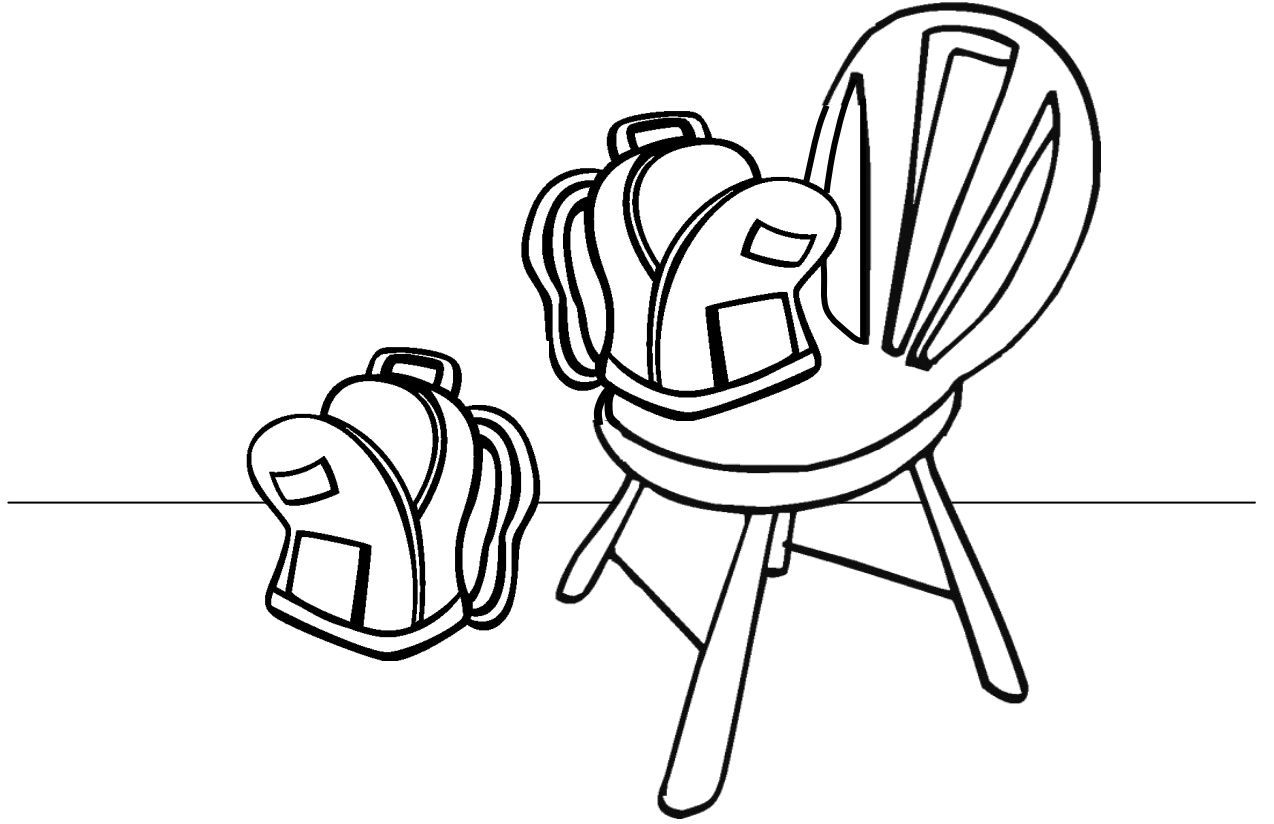



وحدة

المسكن



أصل الشيء إلى الغرفة المناسبة له.

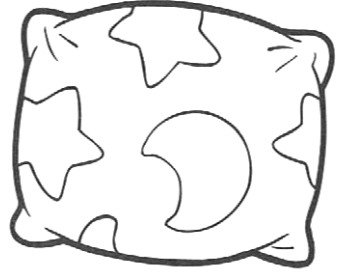
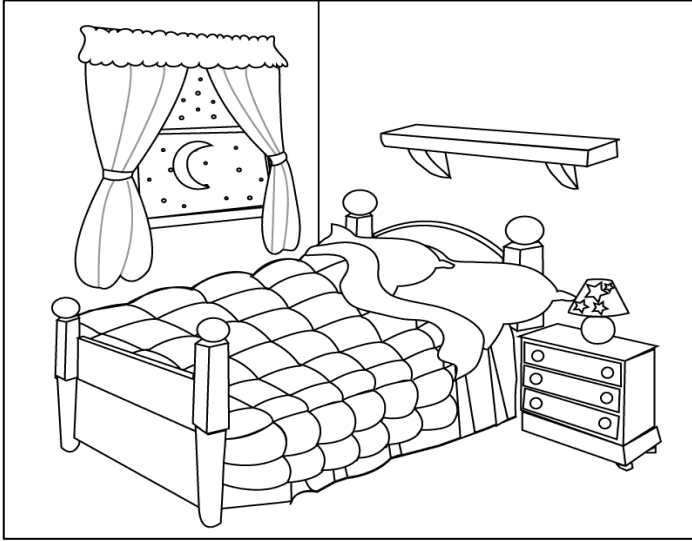

وسادة

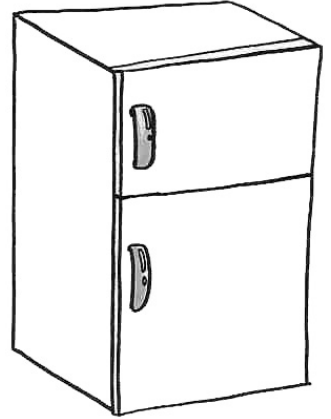

ثلاجة

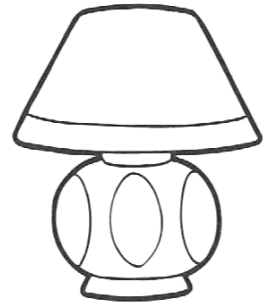
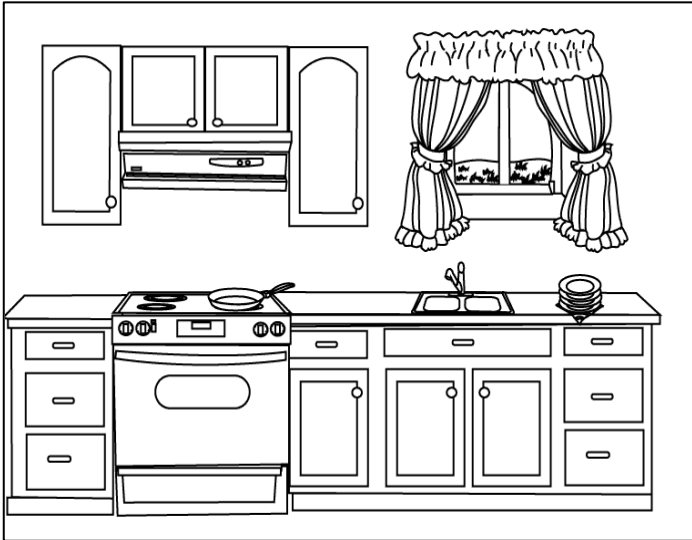

مصباح



ابريق



أصل الشيء إلى الغرفة المناسبة له.



هاتف



مغسلة

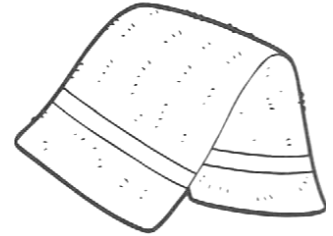

منشفة

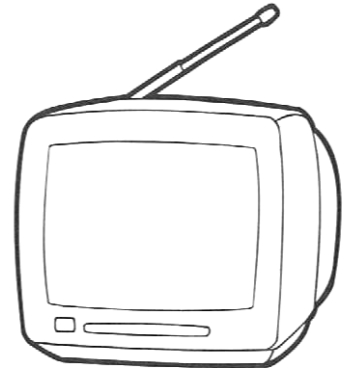

تلفاز

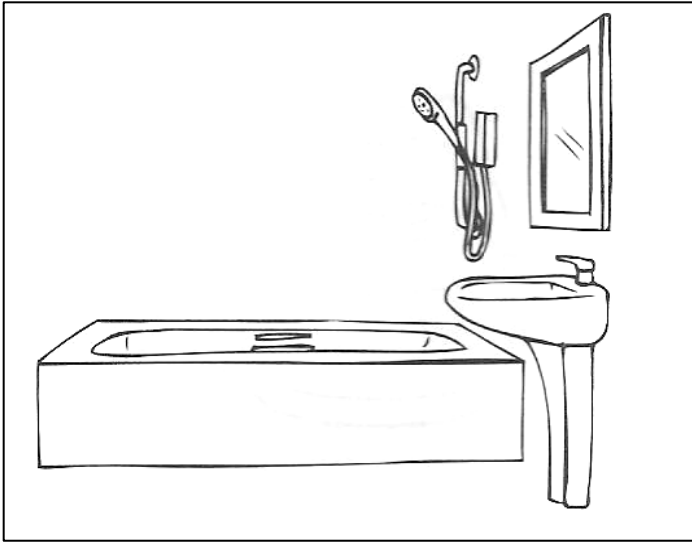
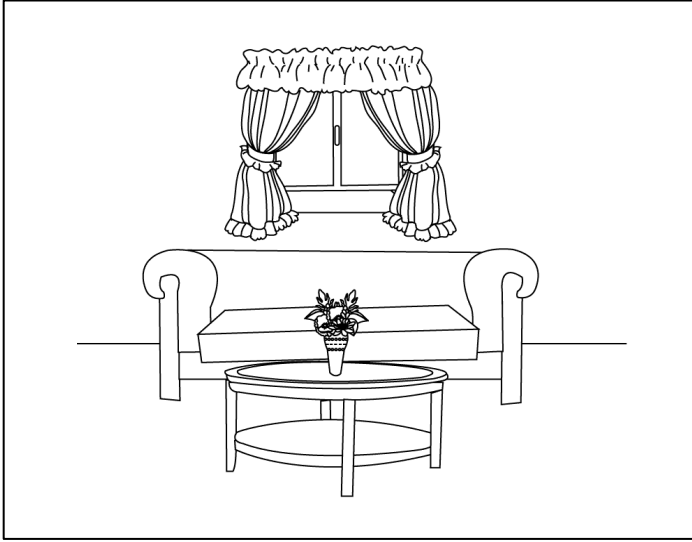

" مغلق ، مفتوح " أحوط المغلق باللون الأحمر والمفتوح بالأزرق.

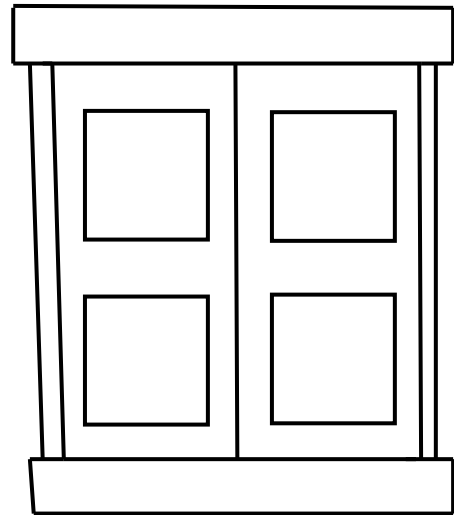
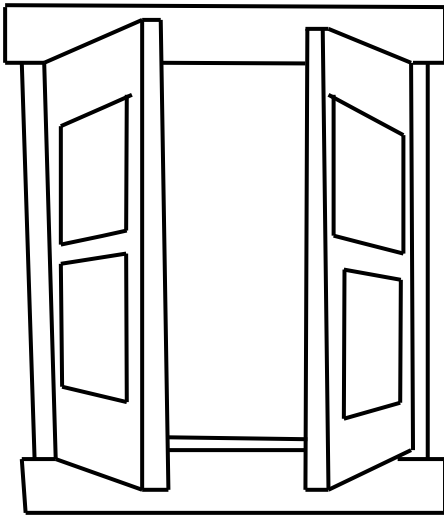
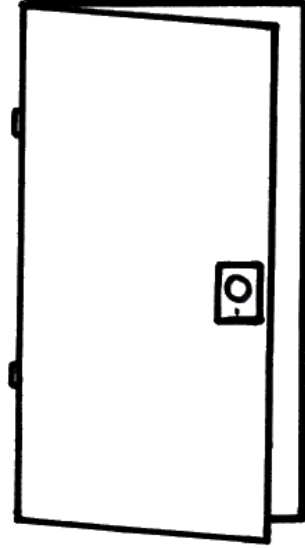
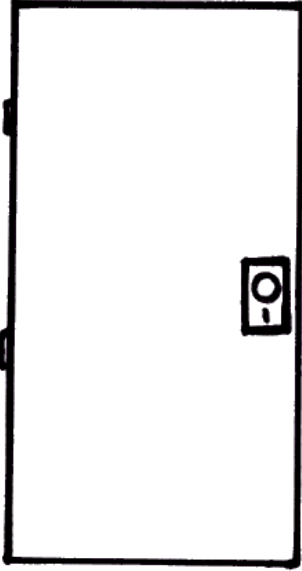

" داخل ، خارج " ألّون الصورة التي تمثل مفهوم " داخل " .

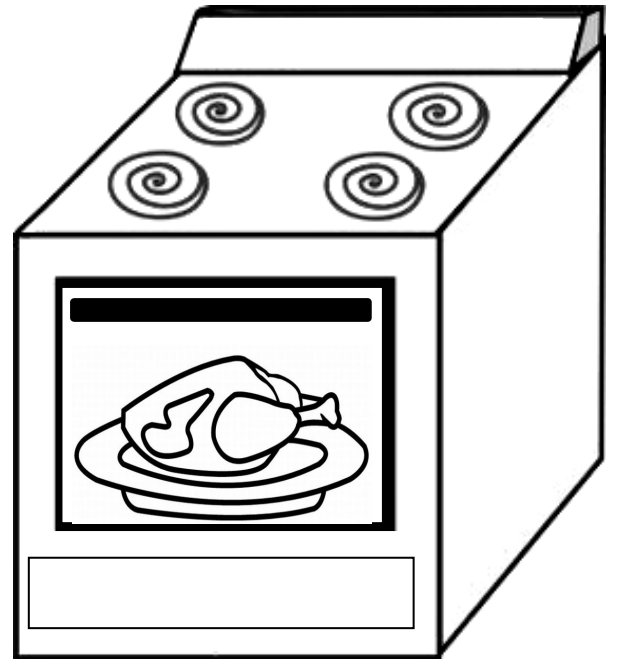
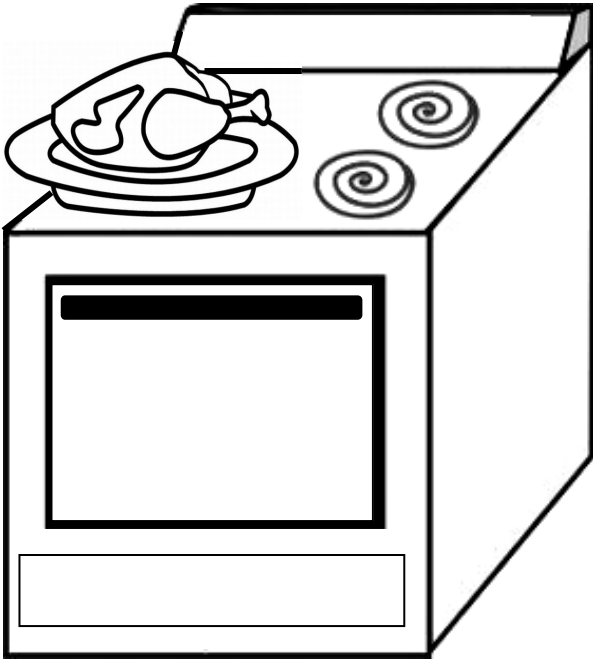
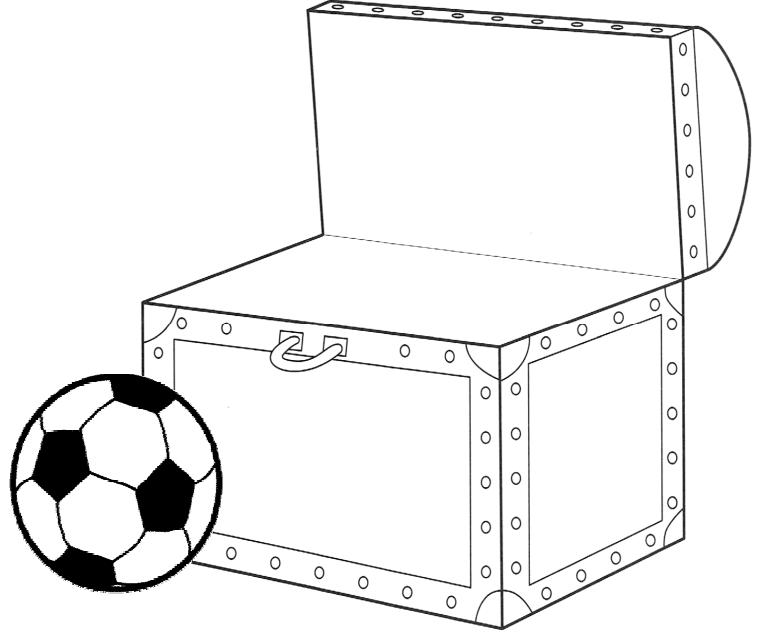
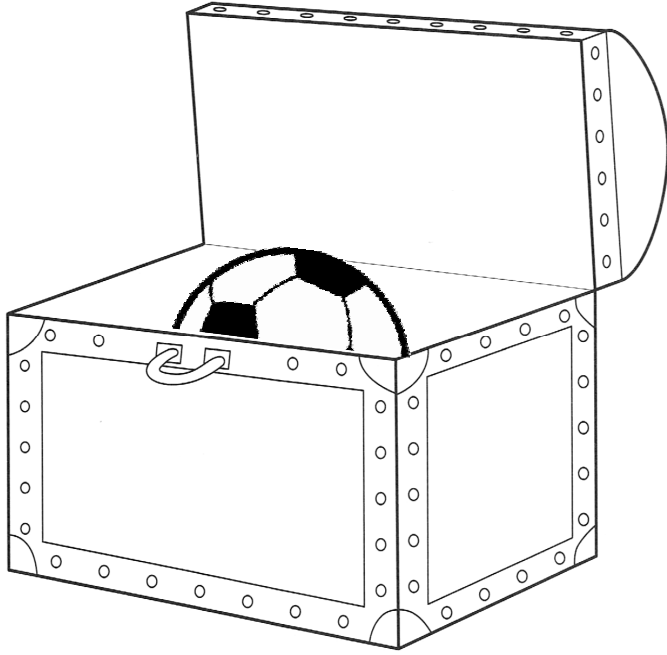

أصل كل مسكن بالمسكن المطابق له من حيث الحجم.

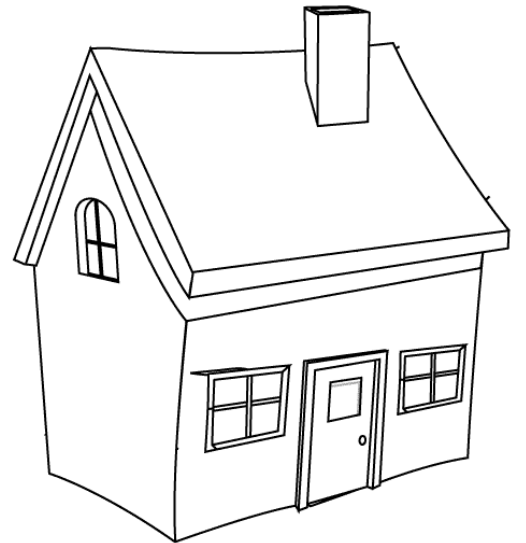
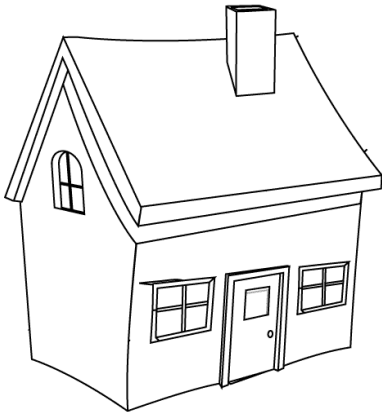
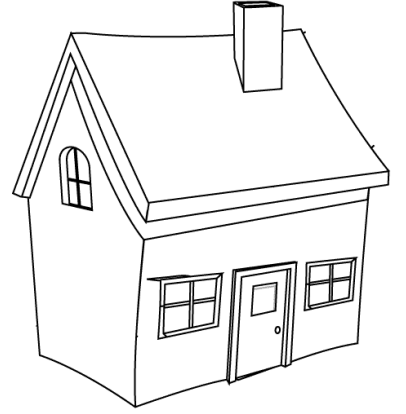
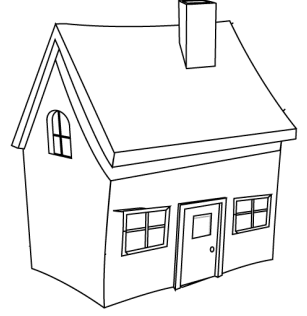
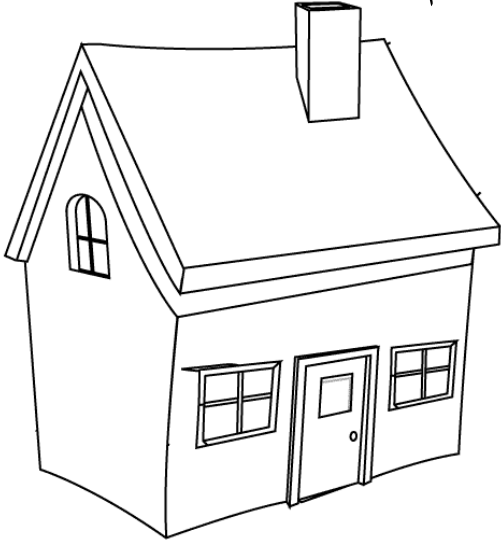



وحدة

رمضان



استقبال شهر رمضان المبارك.

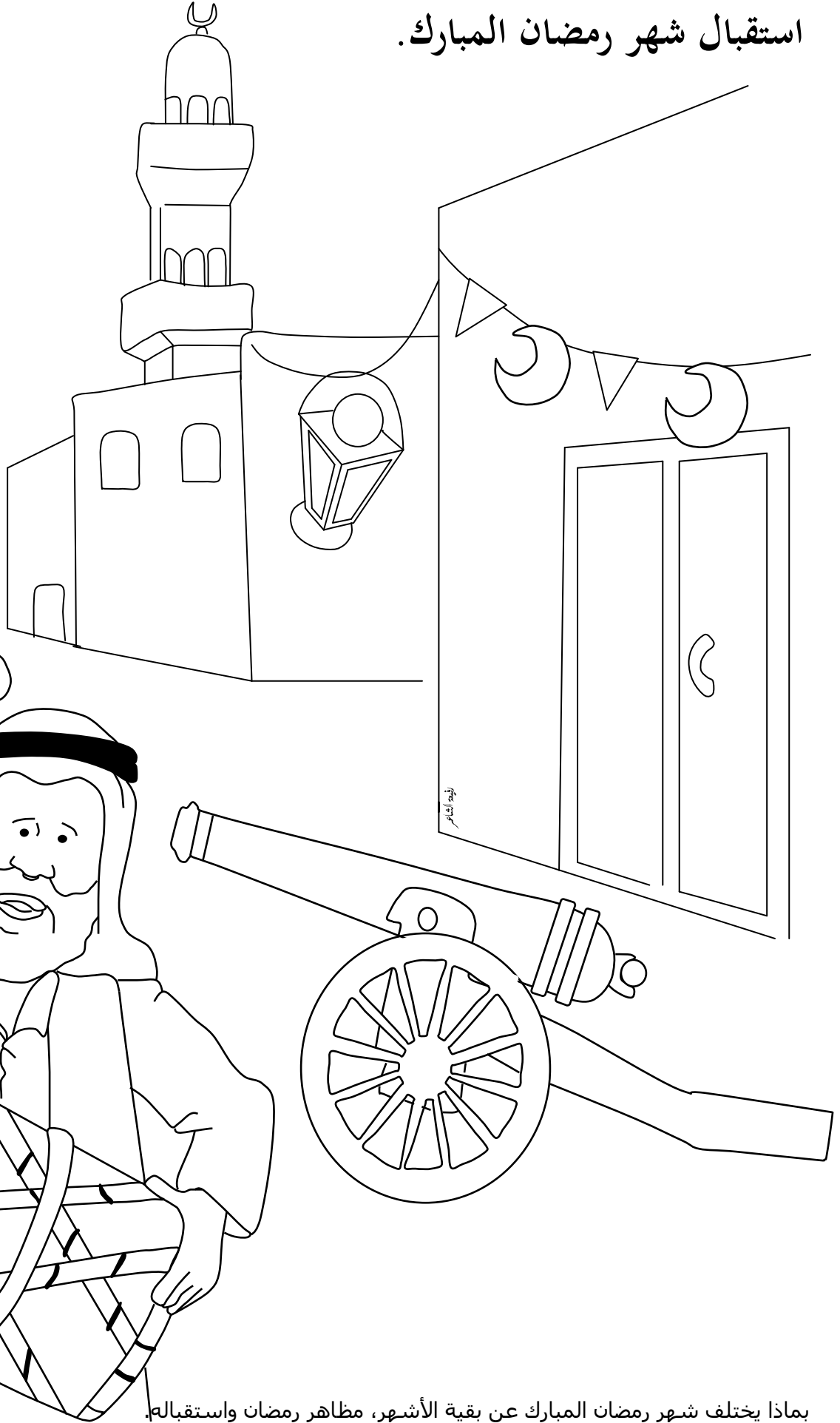
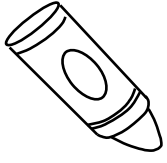

بماذا يختلف شهر رمضان المبارك عن بقية الأشهر، مظاهر رمضان واستقباله.



رمضان

وحداتي



هلال رمضان ، أطابق و أصل.

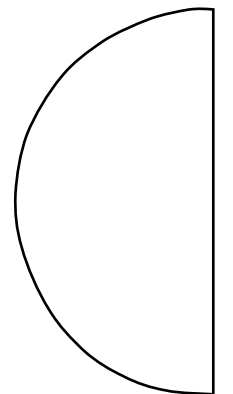
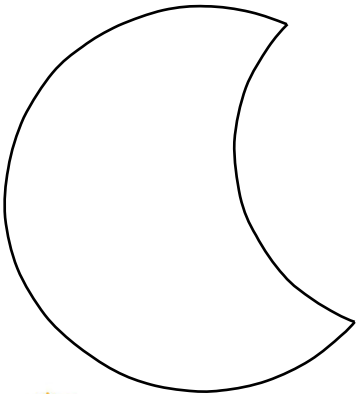
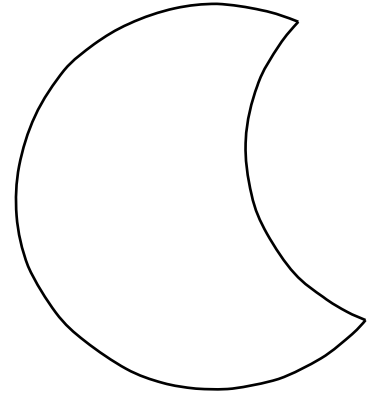
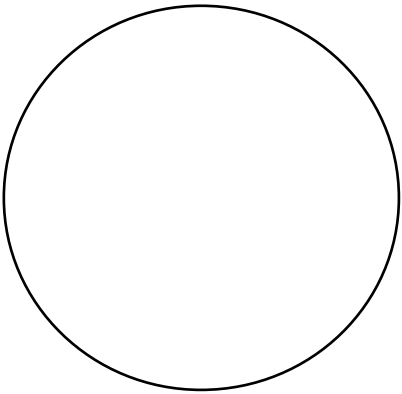
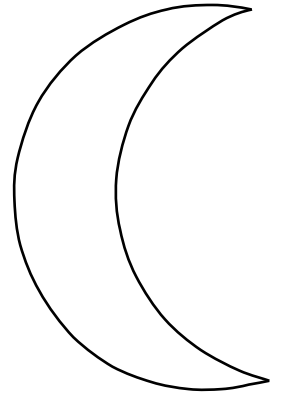
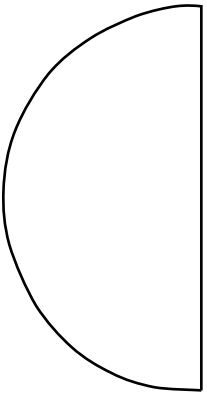
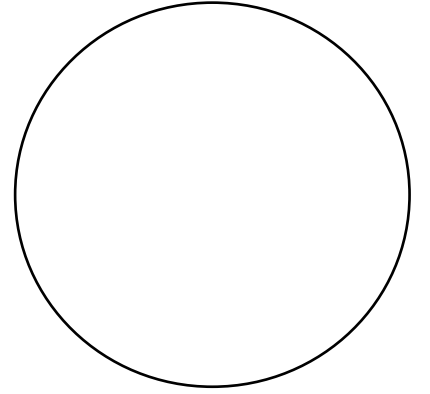
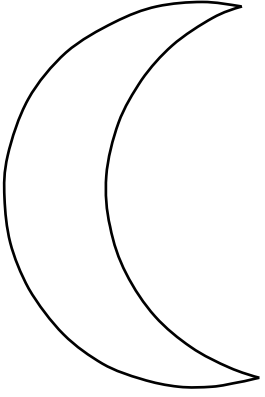

أتعرف على فترات الطعام في رمضان.

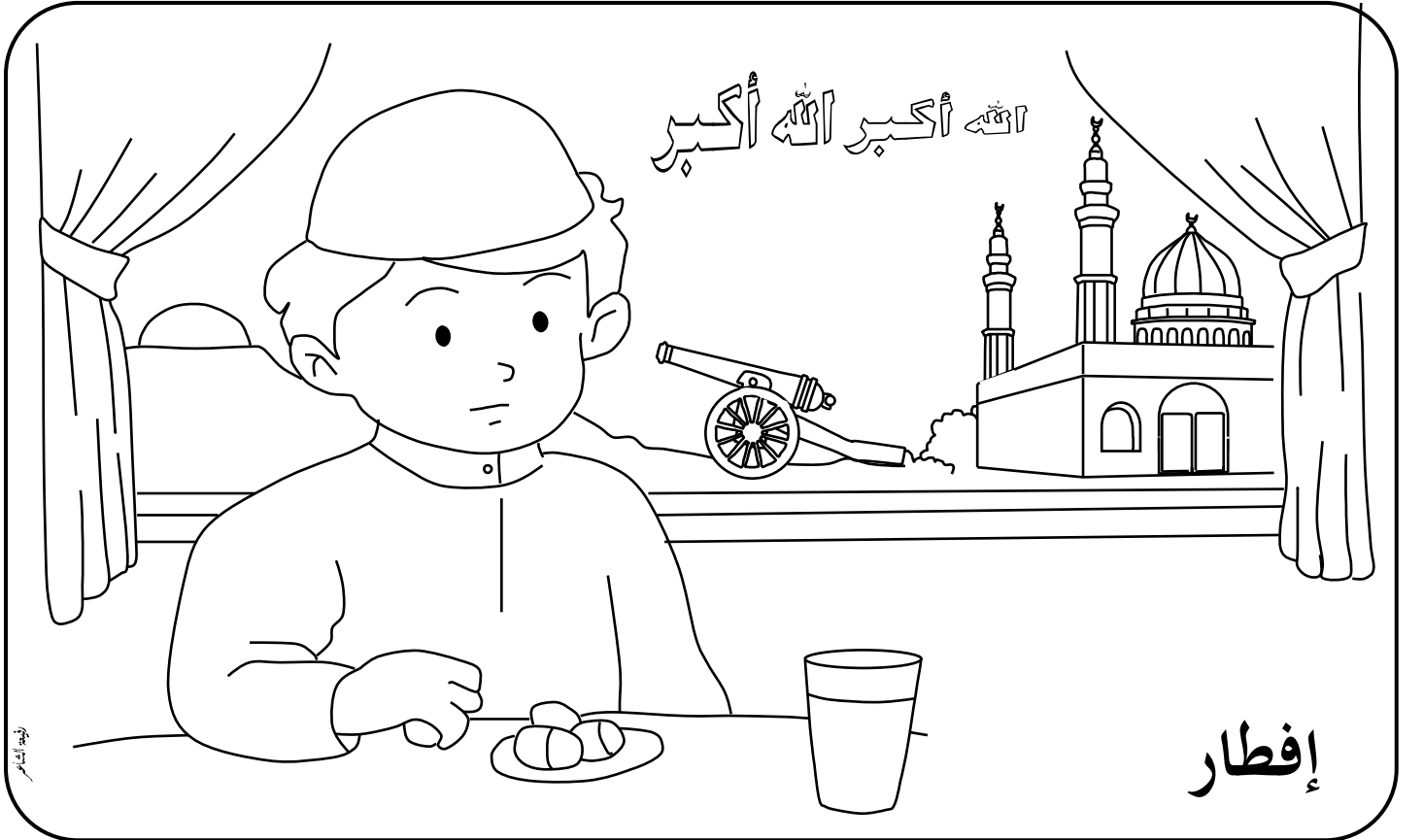
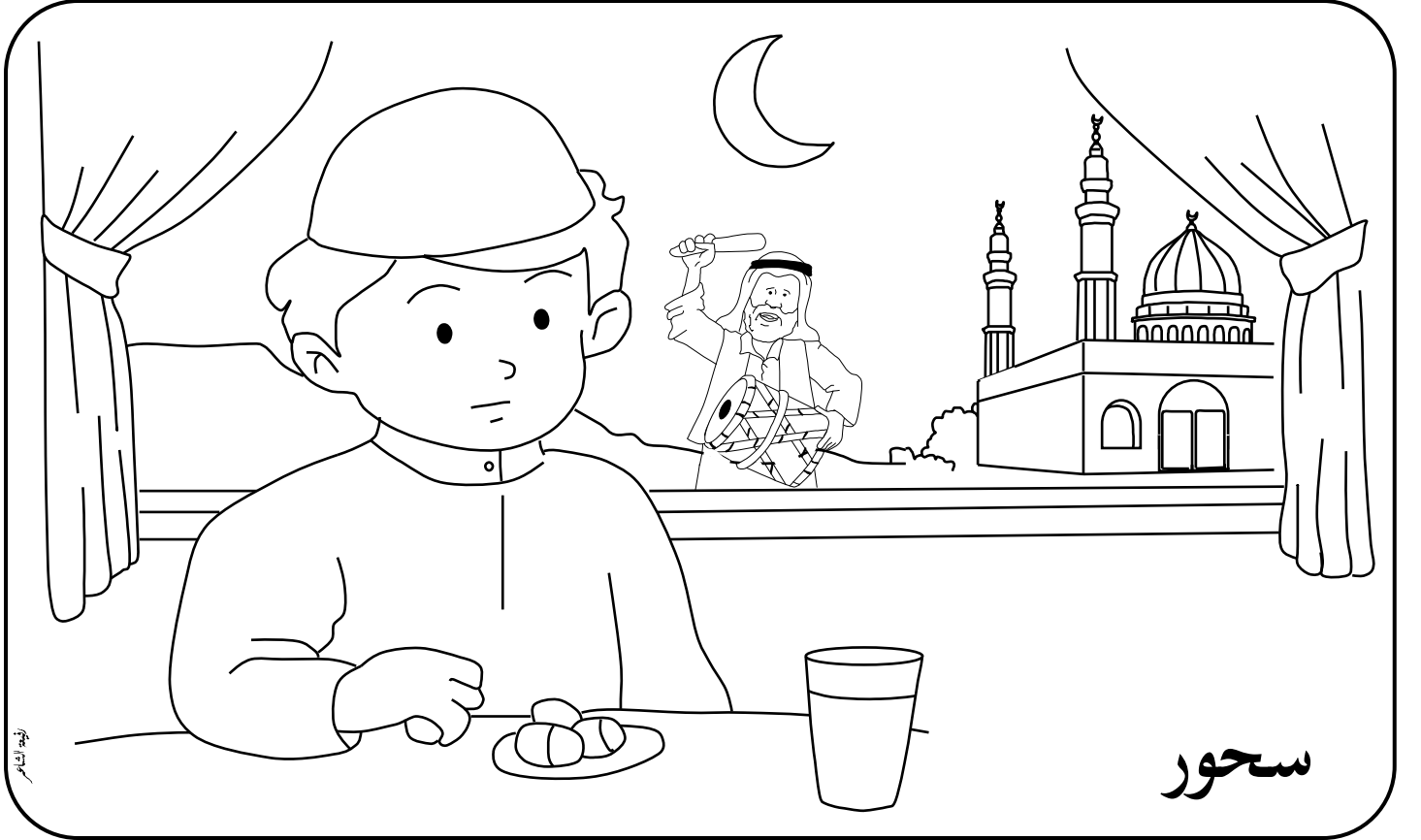

كيف يعرف المسلم وقت السحور و وقت الإفطار؟ ما هو دعاء الإفطار؟



أحوط الأطعمة التي نفضلها في رمضان.



ثريد

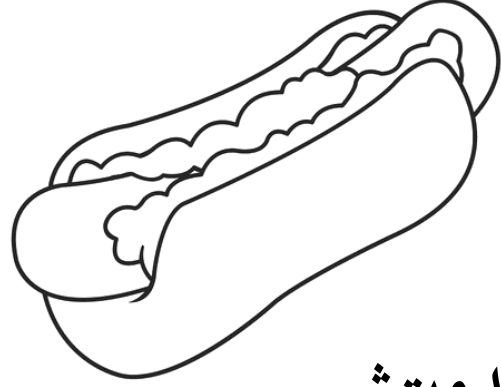

سندويتش

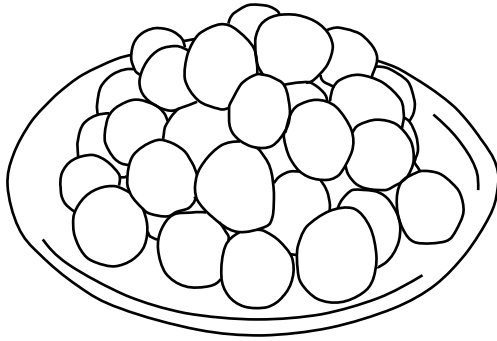

لقيمات

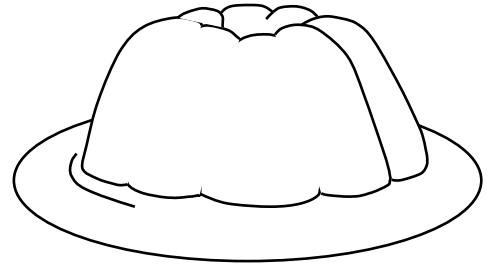

جيلي

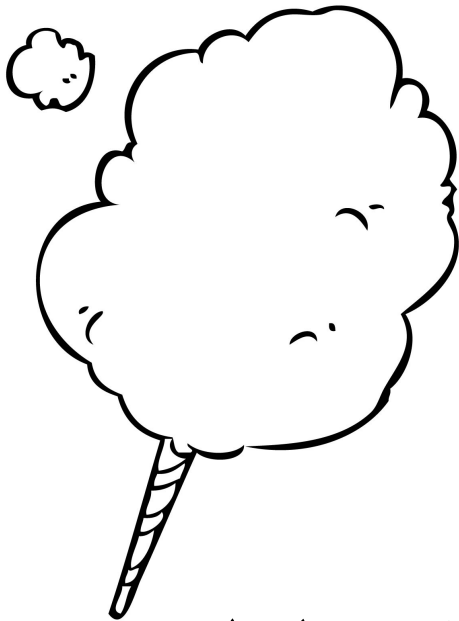

حلوى القطن

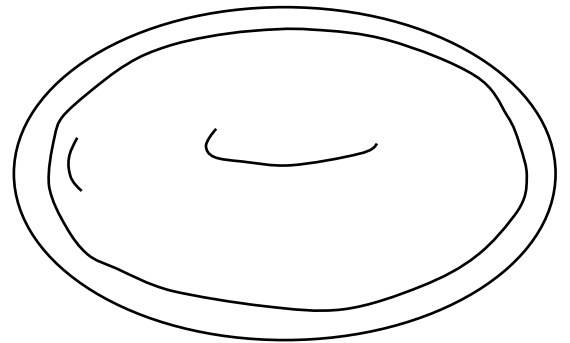

هريس



ماذا يوجد في المسجد؟ ألّون إجابتي.

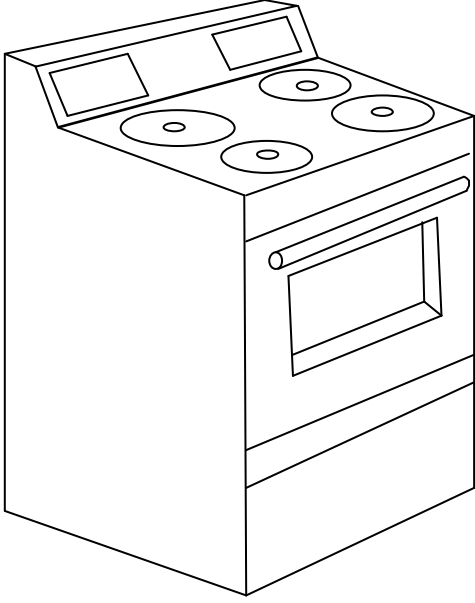

فرن

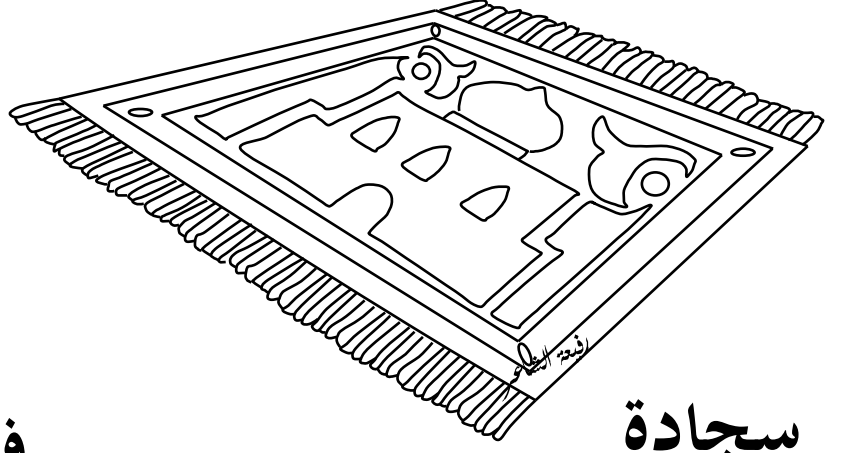

سجادة

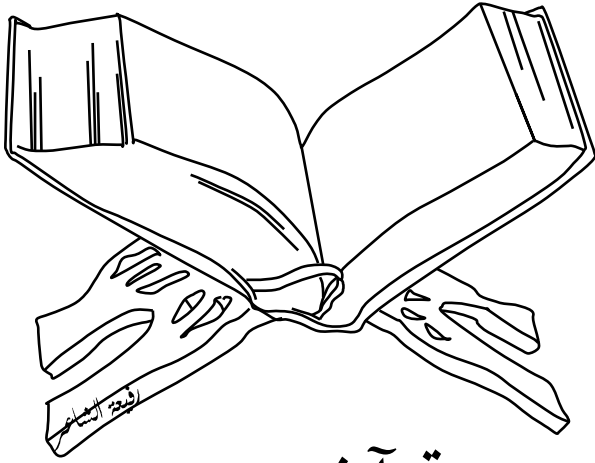

قرآن

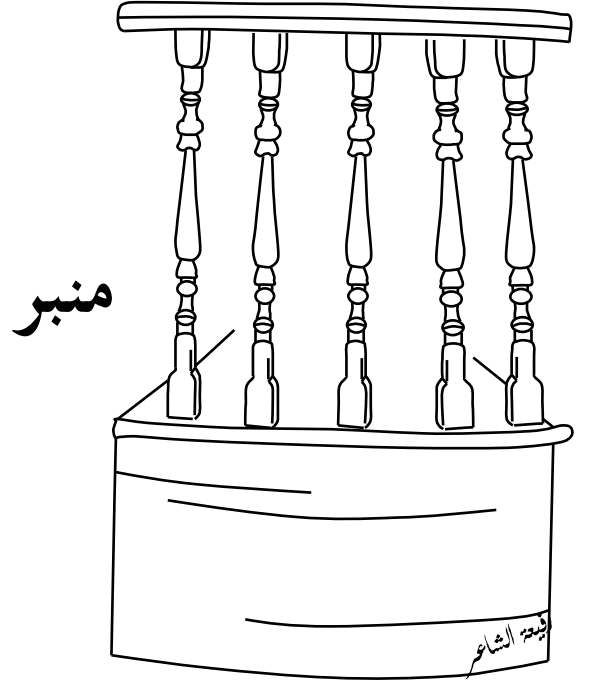

منبر



أرفف

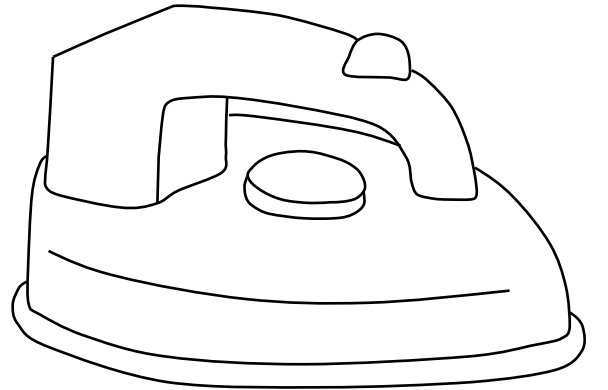

مكواة





وحدة

الملبس



لكل مهنة ملابس، أصل.

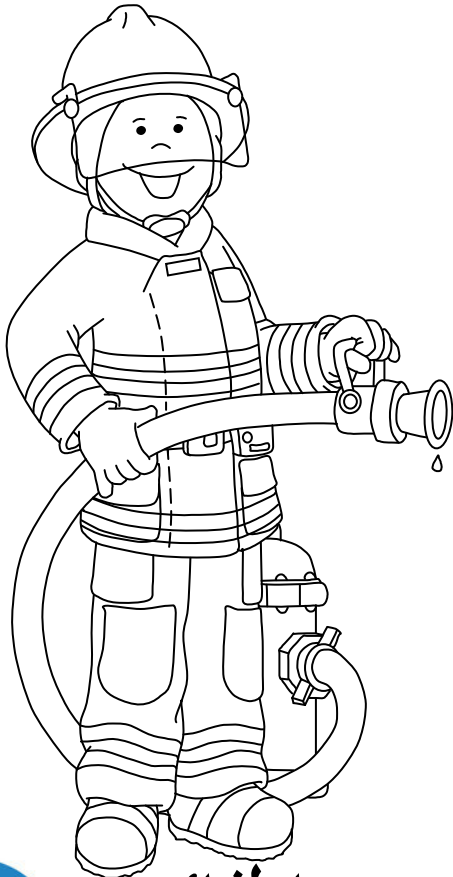
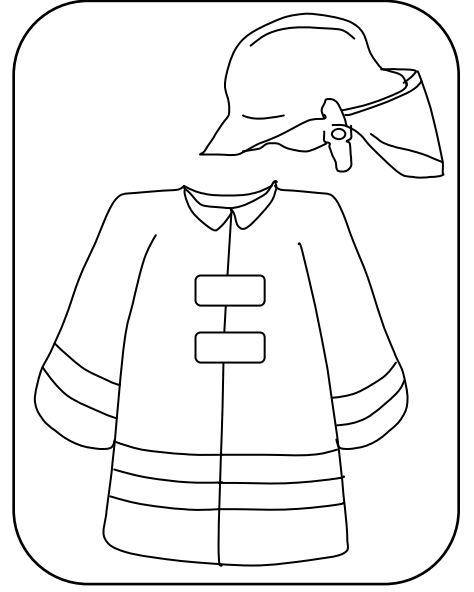
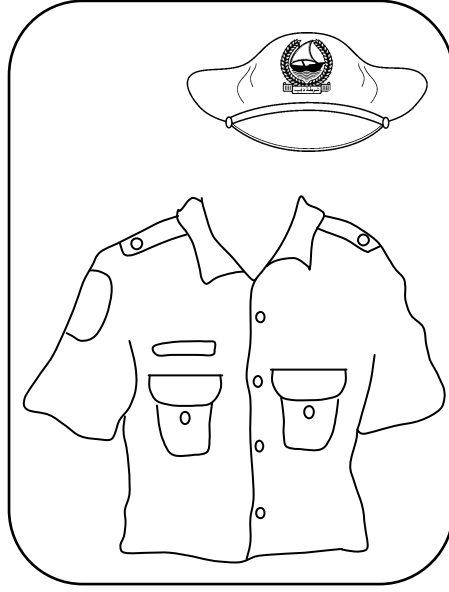
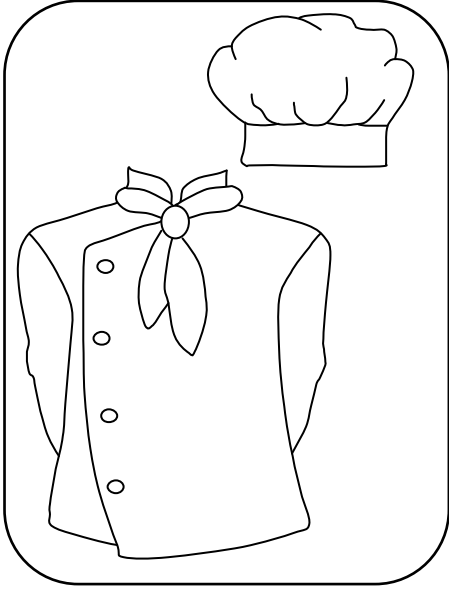

إطفائي



طباخ



شرطي



لكل جو ملبس ، أصل.

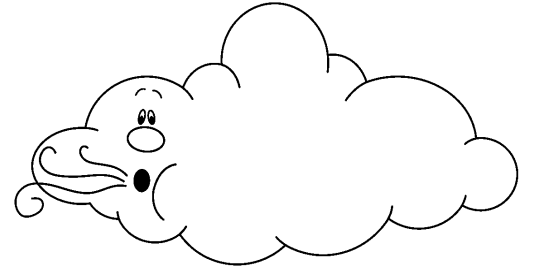

بارد

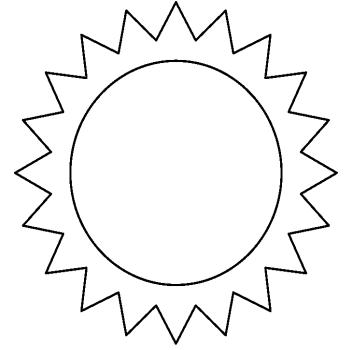
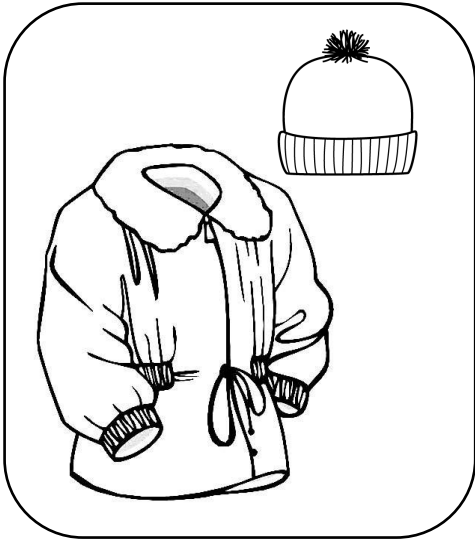

شمس

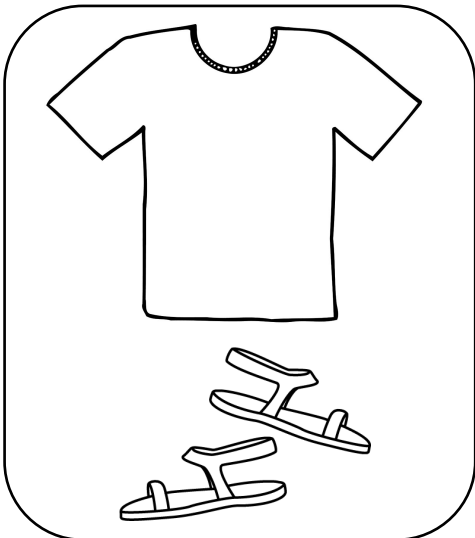

مطر



للملبس آداب، أضع علامة X على الصورة التي تمثل الملبس الذي لا يعجبني.

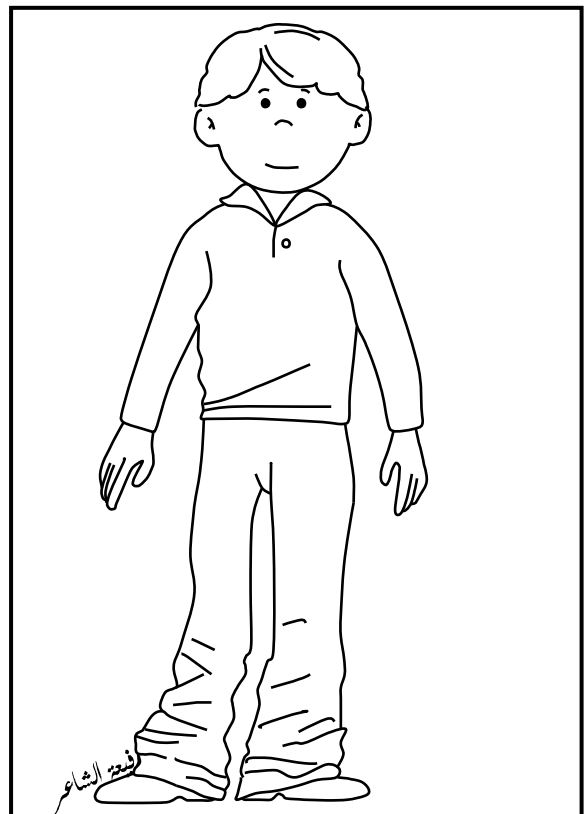
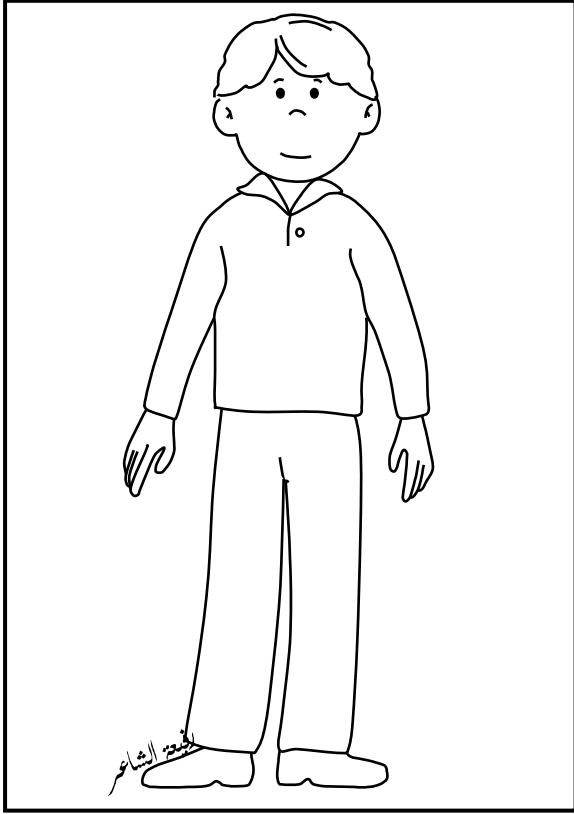
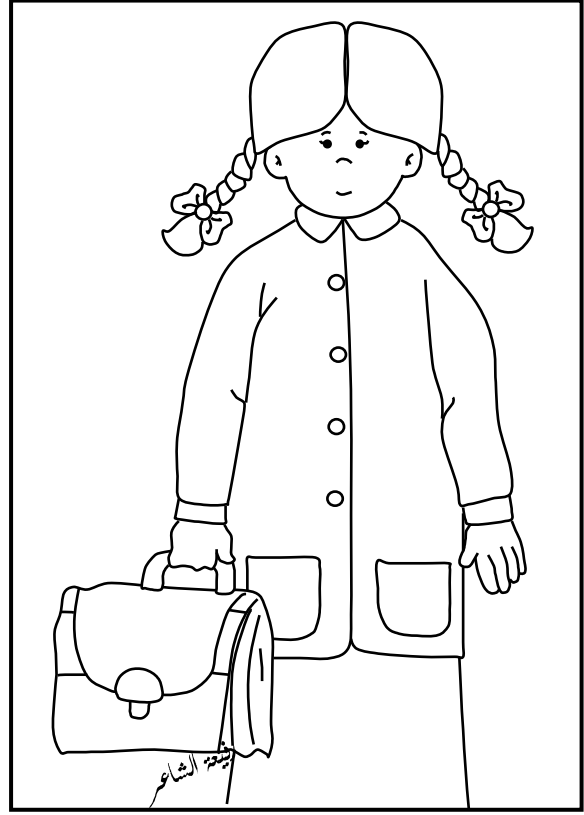

ألون ملابس دولة الإمارات العربية المتحدة.

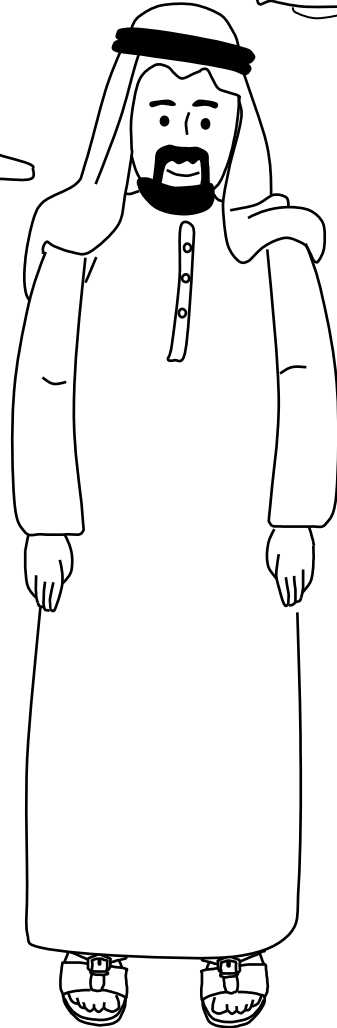
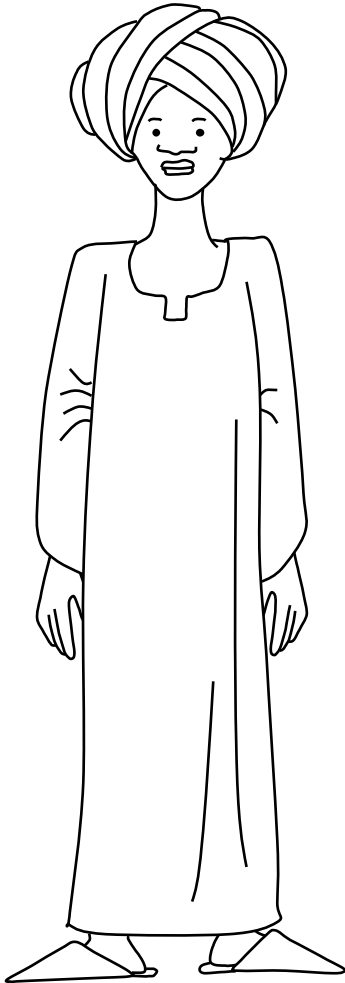
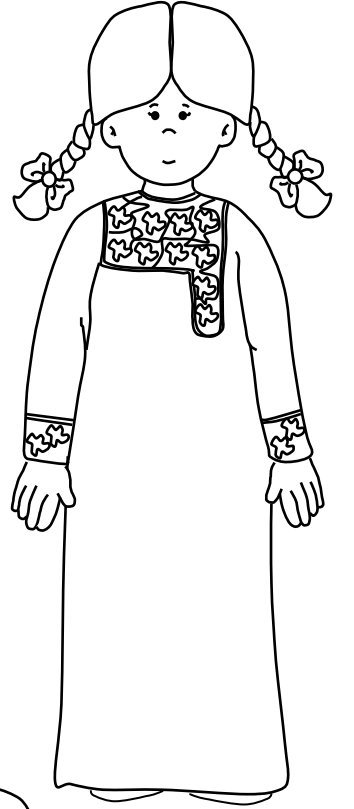
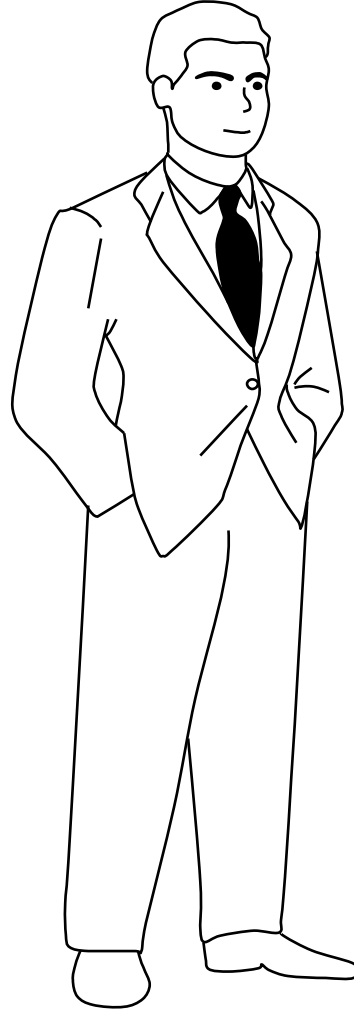
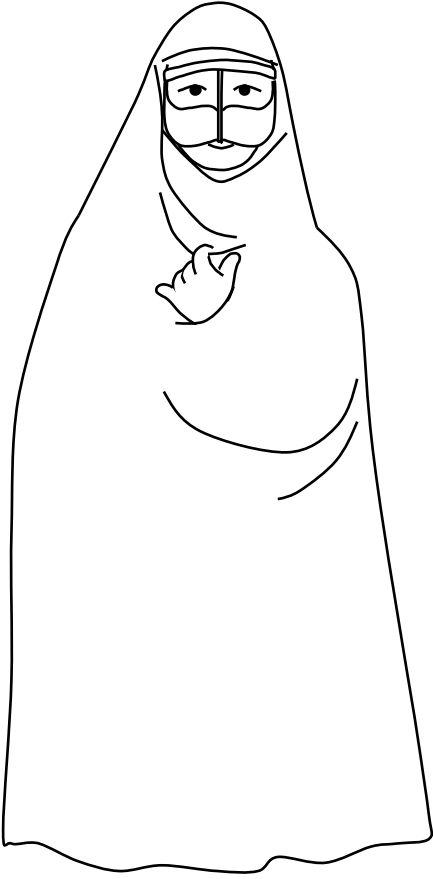



وحدة

اليوم الوطني



أخط اسم بلادي الإمارات.

الإمارات

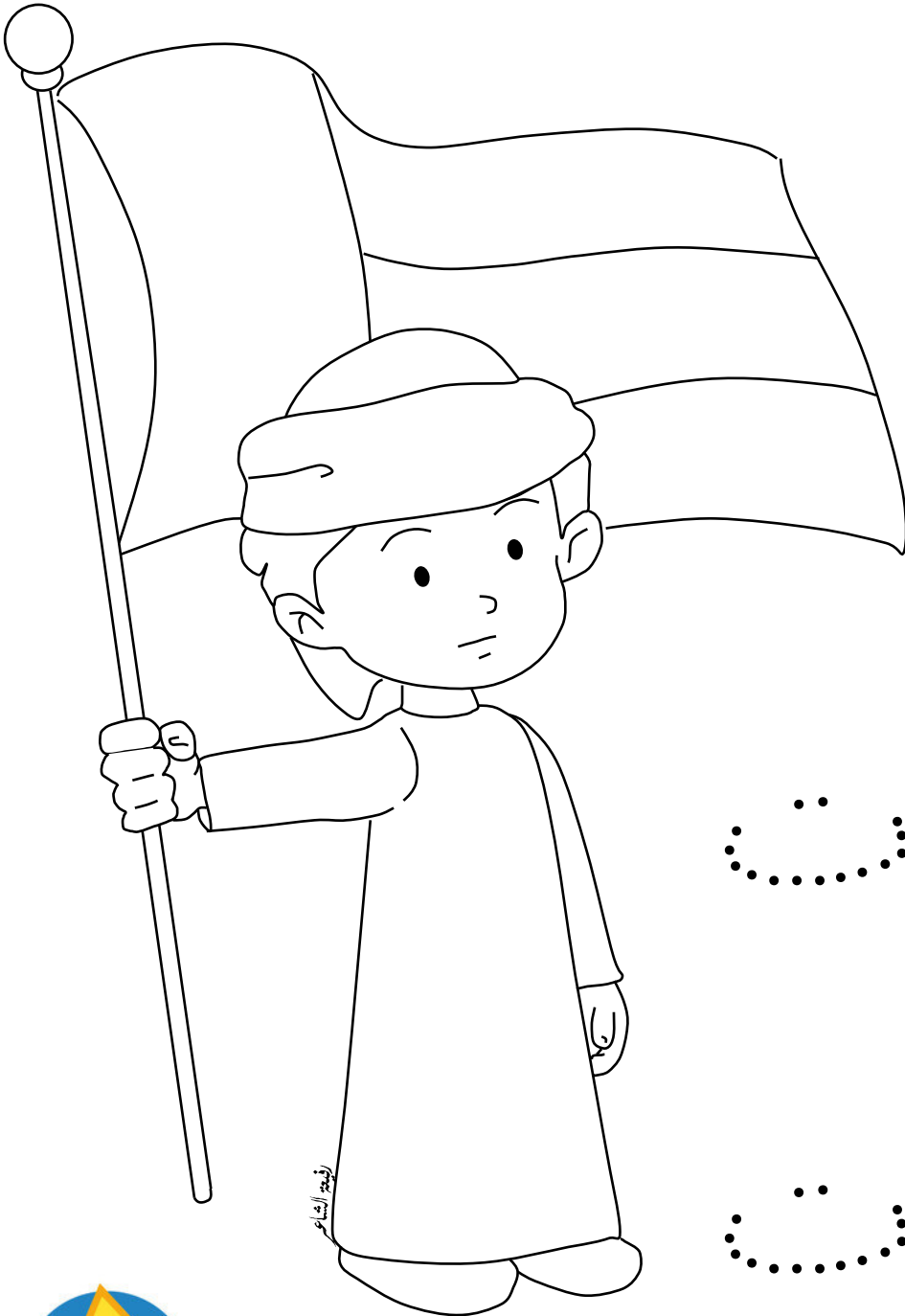

الإمارات

الإمارات



أحوط رئيس دولة الإمارات، وأحوط حاكم الإمارة التي أعيش فيها.

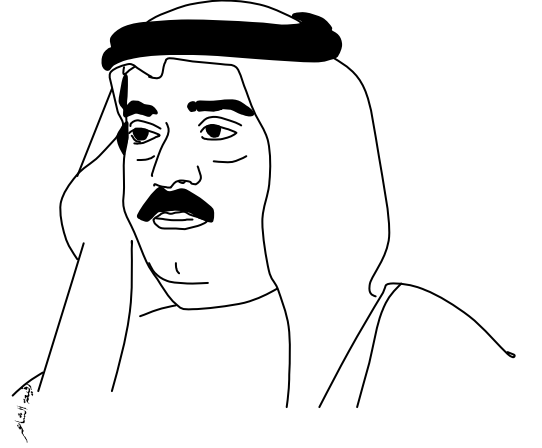

أخطط خريطة دولة الإمارات، أبحث عن الإمارة التي أعيش فيها وأحوّطها.



ألون مظاهر الاحتفال باليوم الوطني.



كرة السلة



الألعاب النارية



نقش الحناء



صيد السمك

الرقصات التراثية





وحدة

الطعام والشراب



أحوّط مجموعة الطعام بدائرة ومجموعة الشراب بدائرة أخرى.

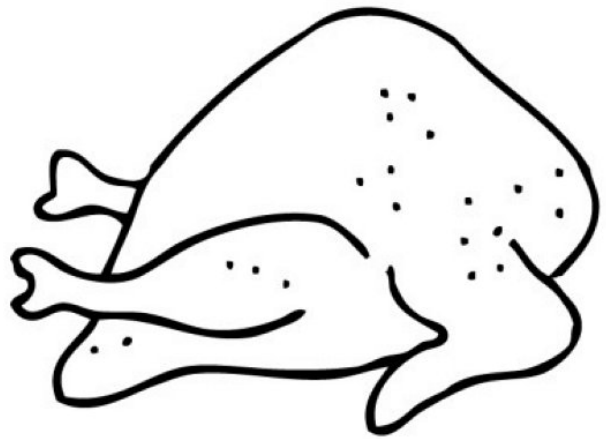
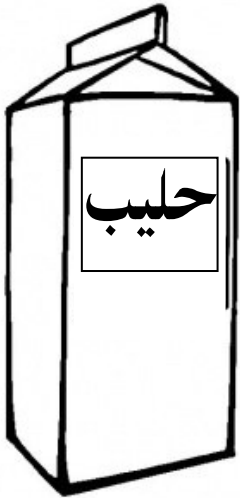
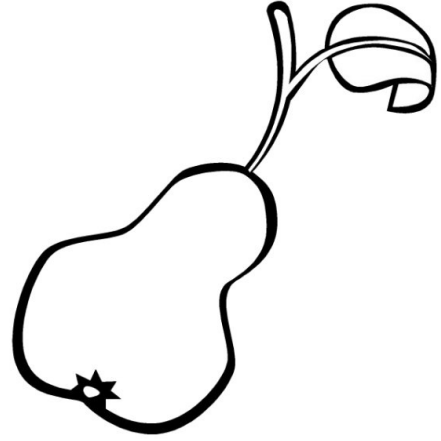
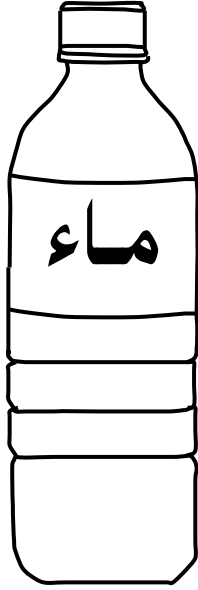
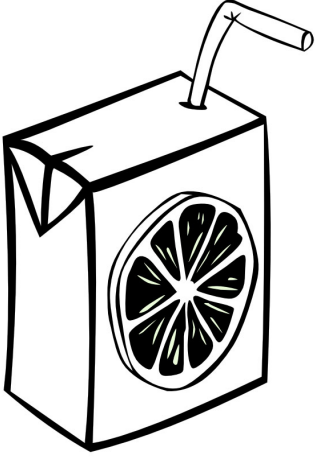

أصل الفاكهة بشكلها الداخلي.

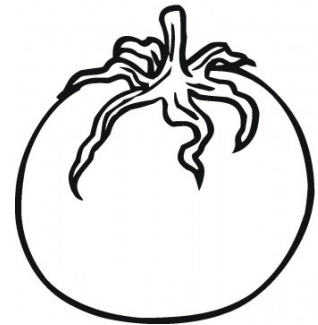
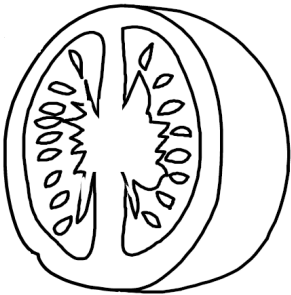
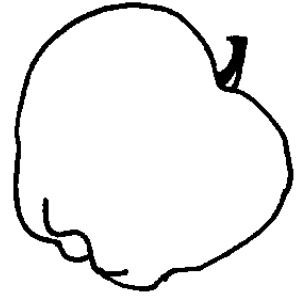
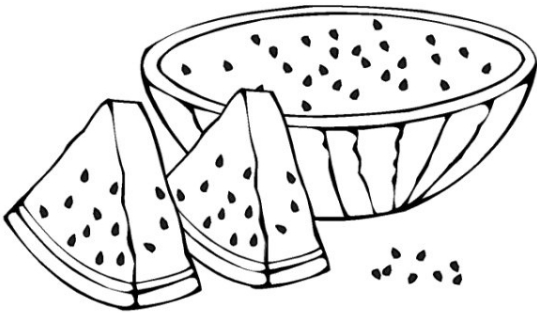
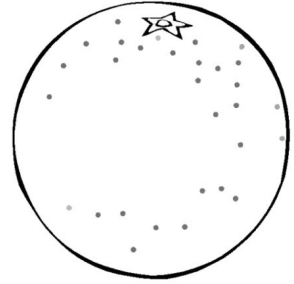
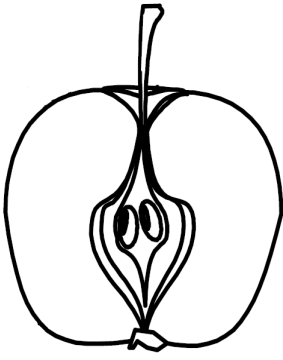
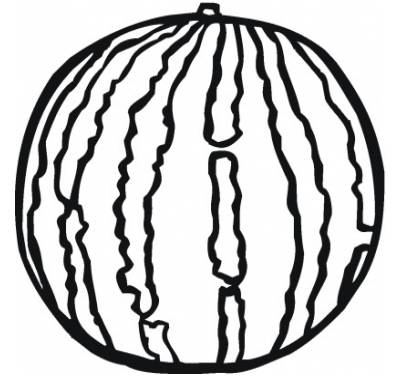
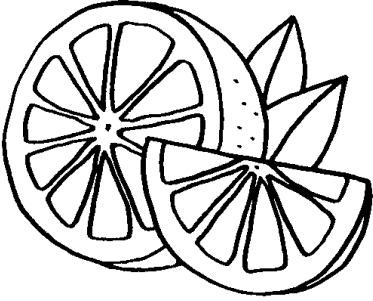

بعض الأطعمة تطهى وبعضها لا تطهى ، ألّون الأطعمة التي تطهى .

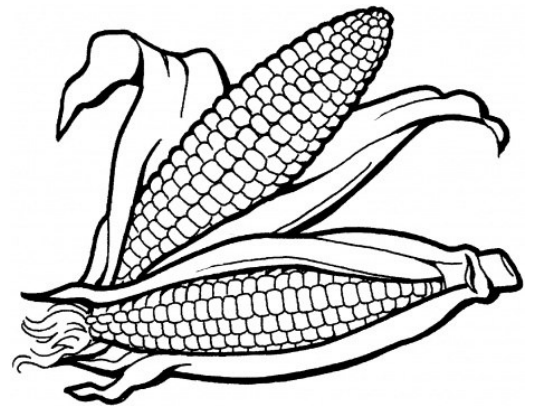
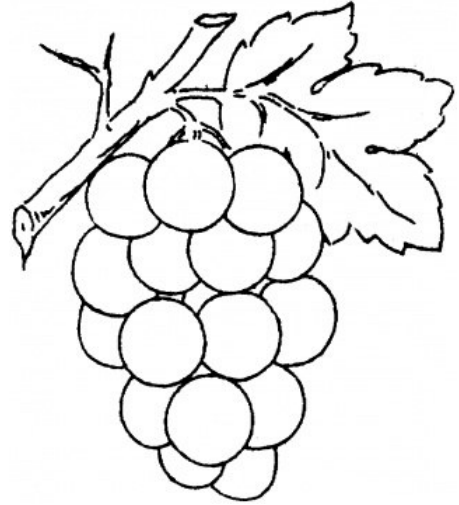
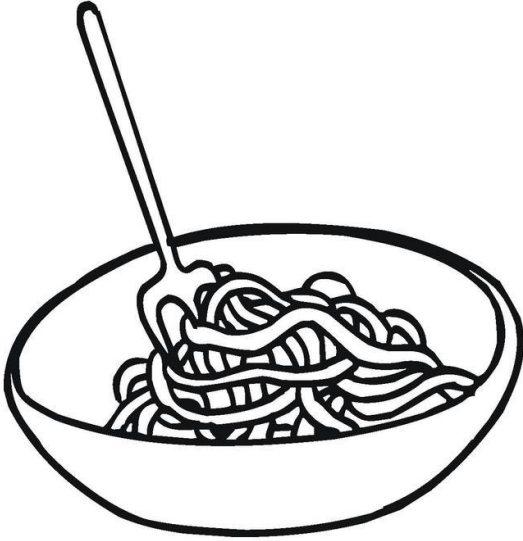
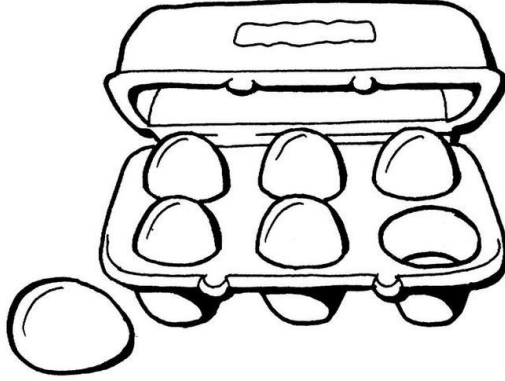
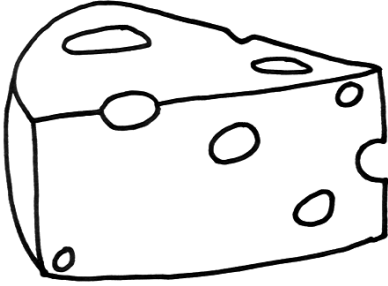
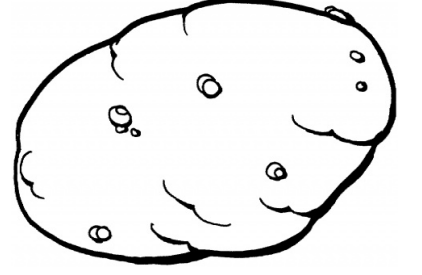
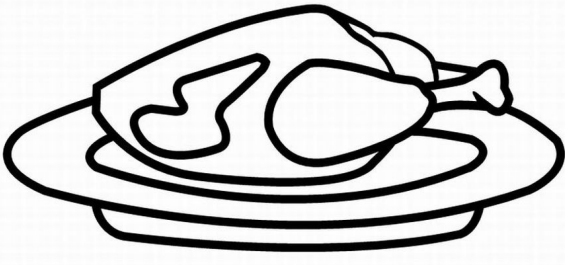

ينتظر أحمد وجبة إفطار و وجبة غداء و وجبة عشاء، أصل.

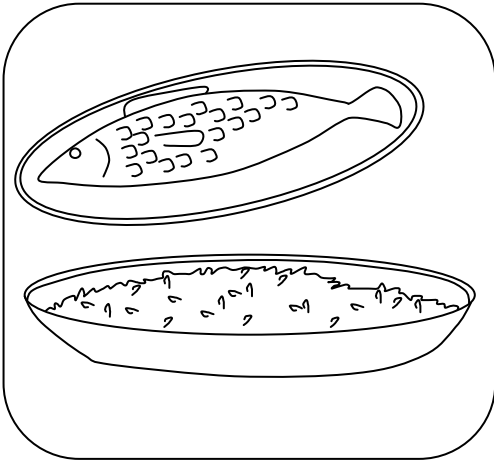
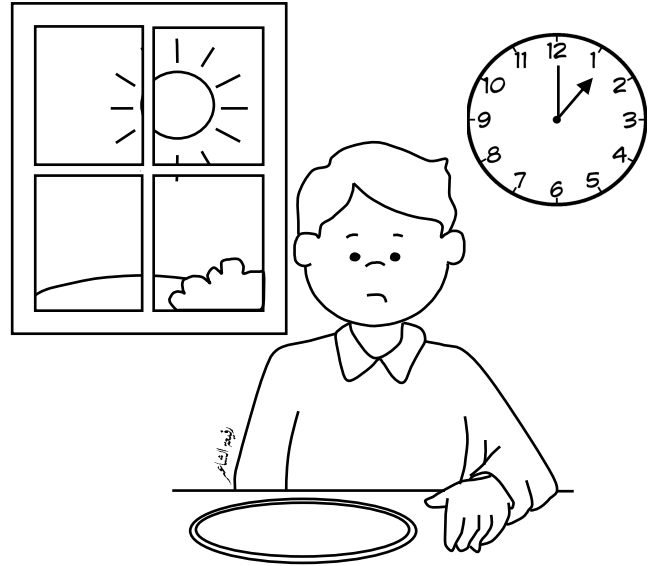
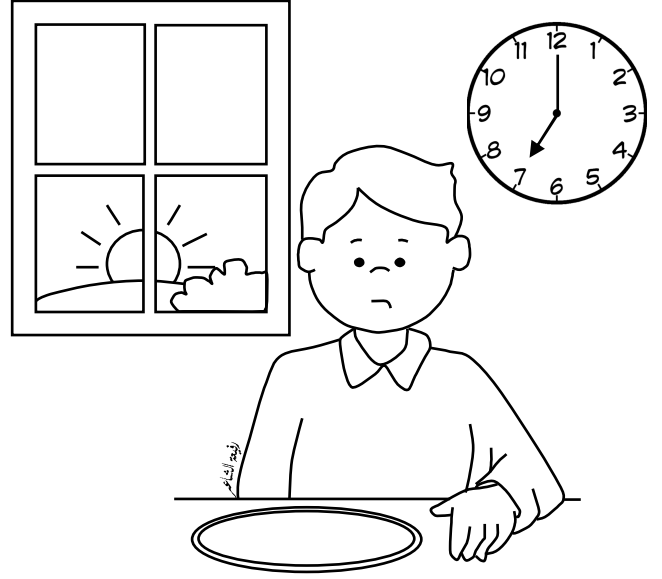
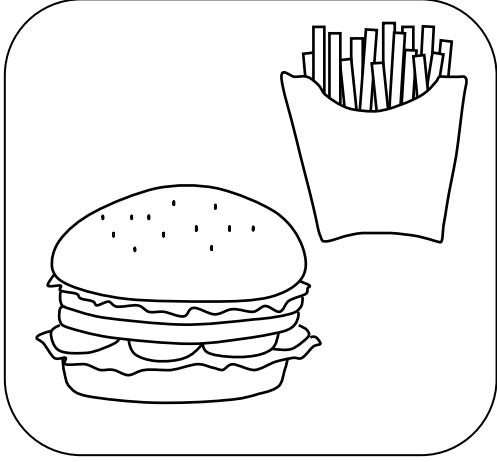

أحوط الأطعمة الصحيّة.

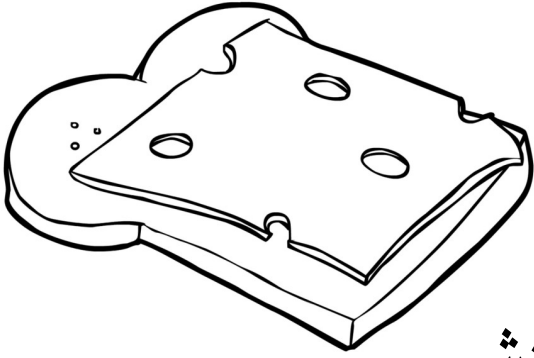

سندويش

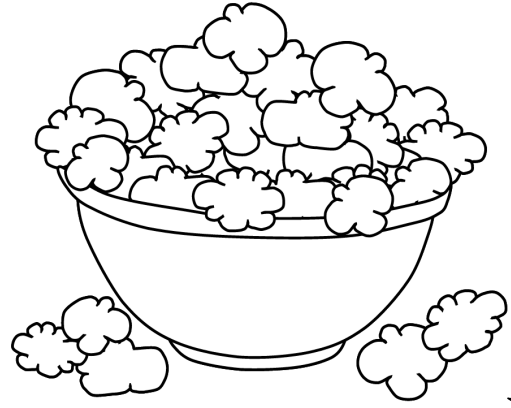

فشار

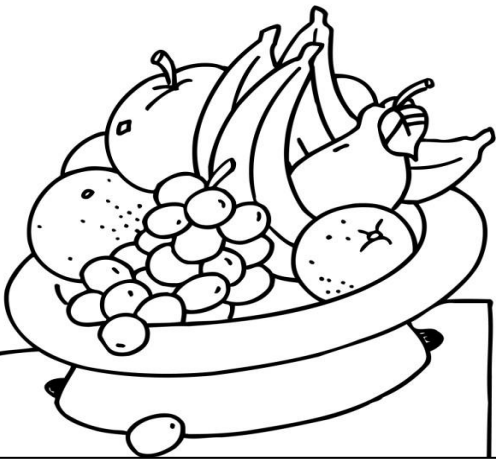

فواكه

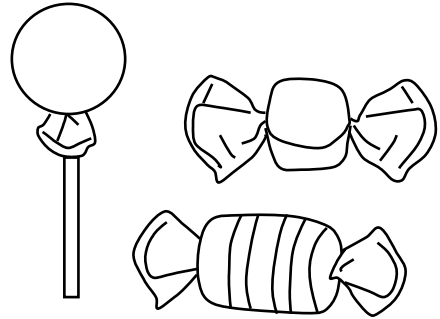

سكاكر



مشروبات غازية

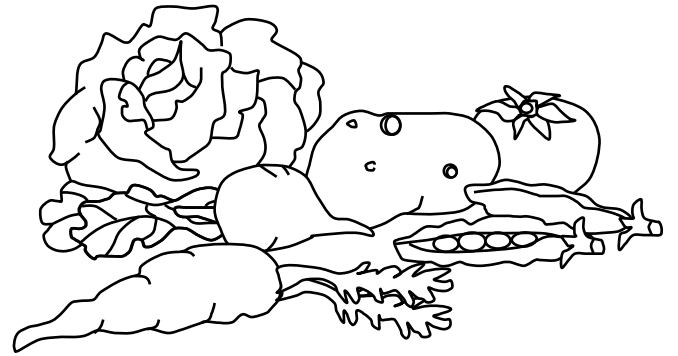

خضروات

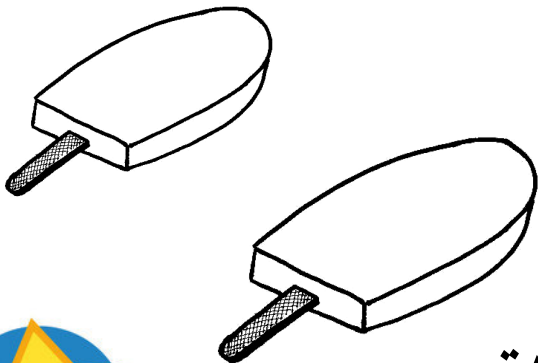

مثلجات

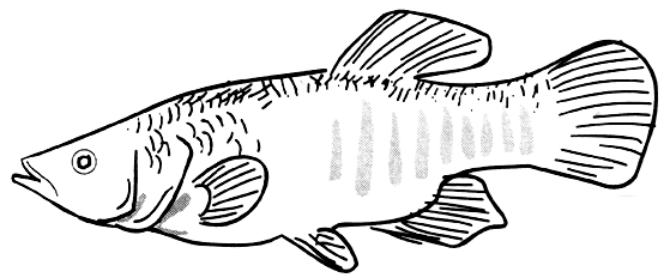

سمك



أصل الطعام بالمكان الصحيح لحفظه.

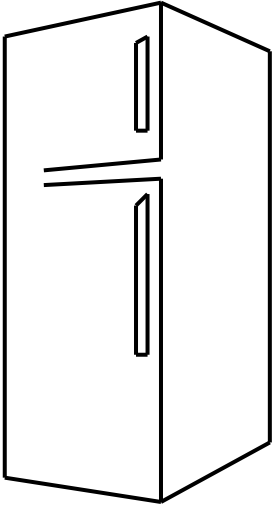

ثلاجة

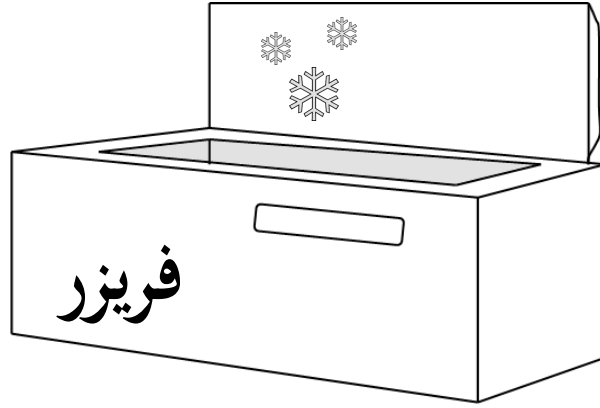

فريزر

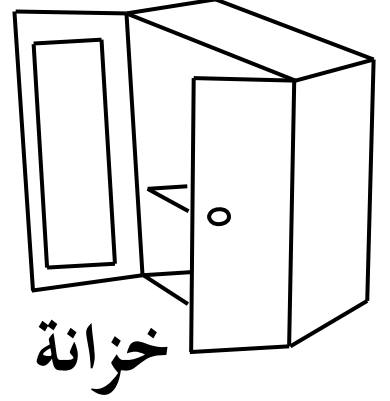

خزانة

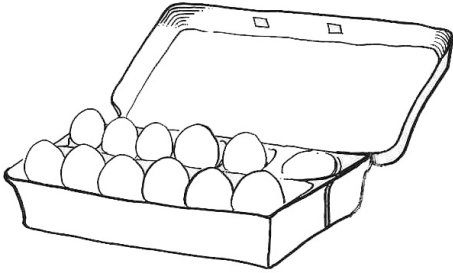

بيض

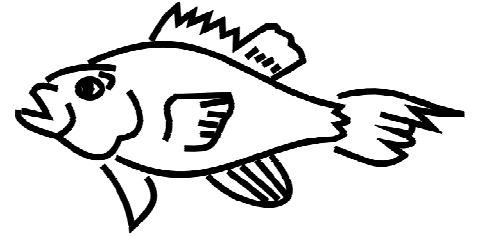

سمك

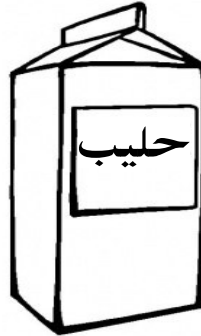

حليب



معلبات

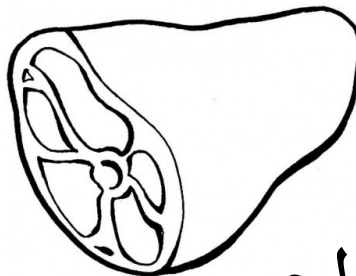

لحم



شيبس
رقائق البطاطا





وحدة

الحيوانات



أصل الحيوان بشكل جلده.

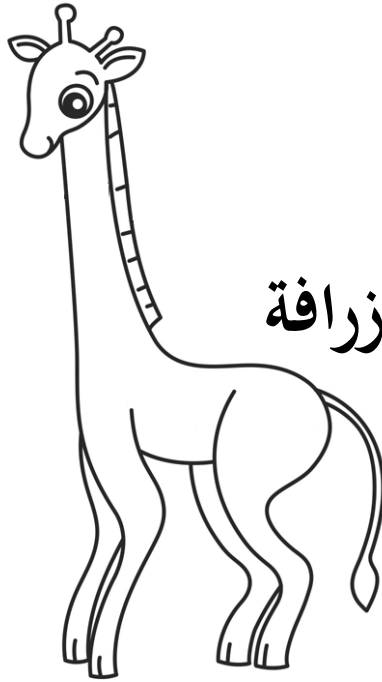
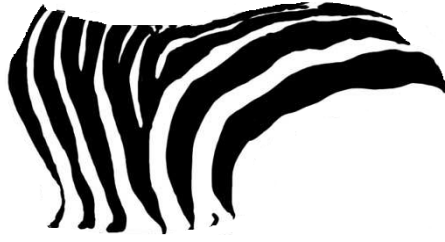
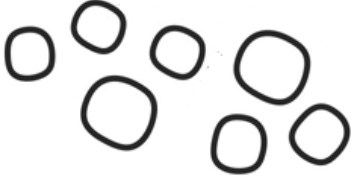

زرافة

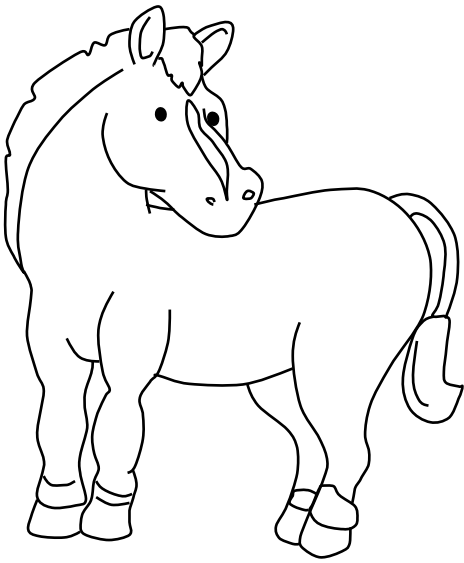

حمار وحشي

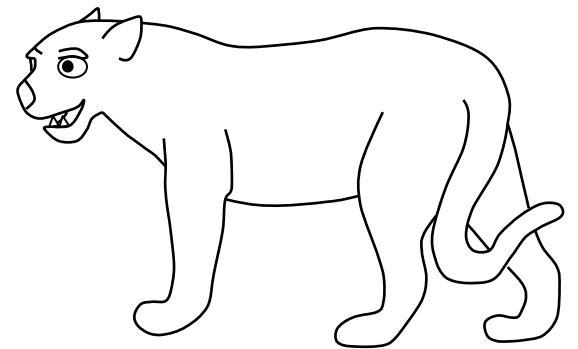

فهد



أحوط الحيوانات الأليفة.

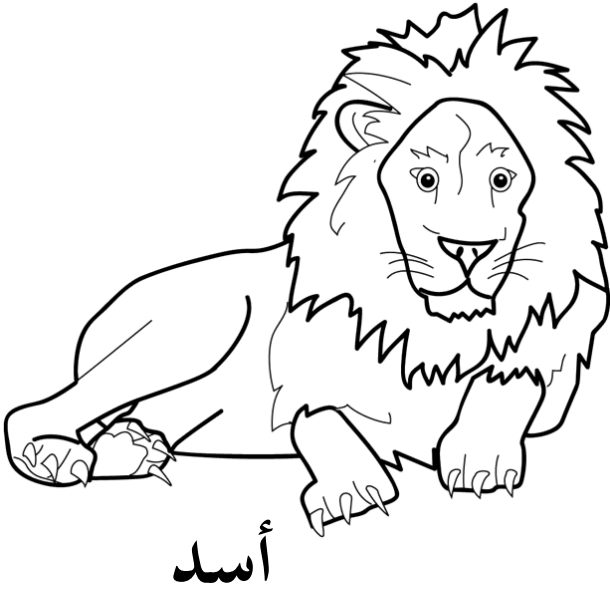

أسد

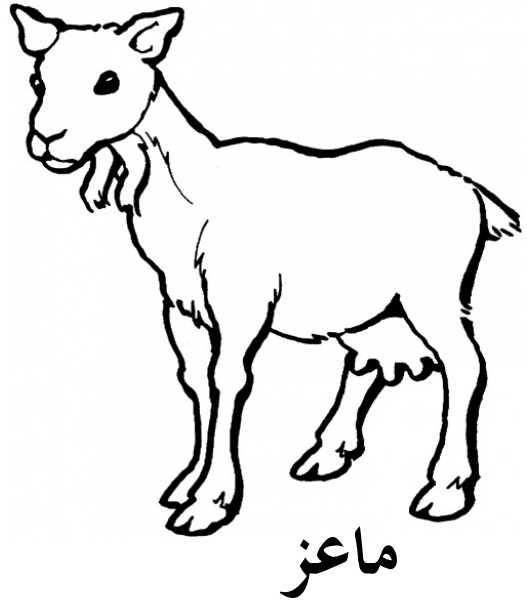

ماعز



قطة

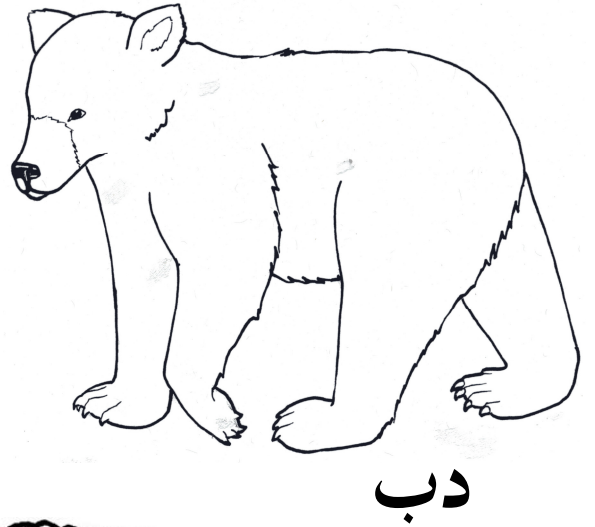

دب



ديك

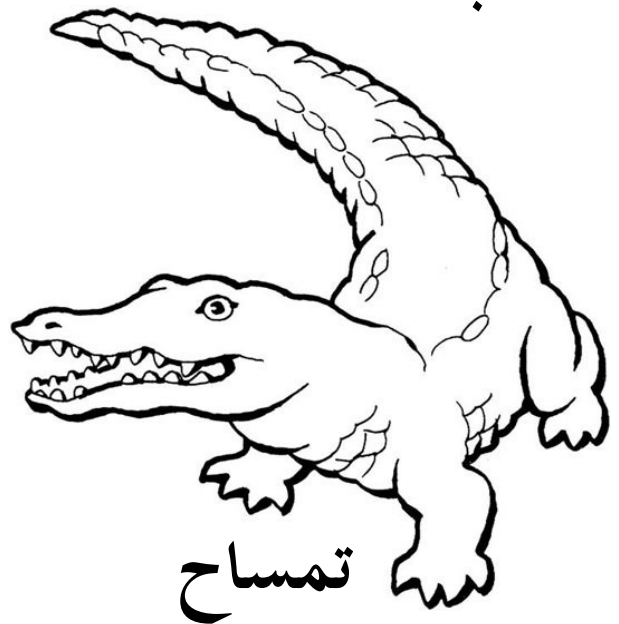

تمساح



فوائد الحيوانات، أخطط وأتعلم.

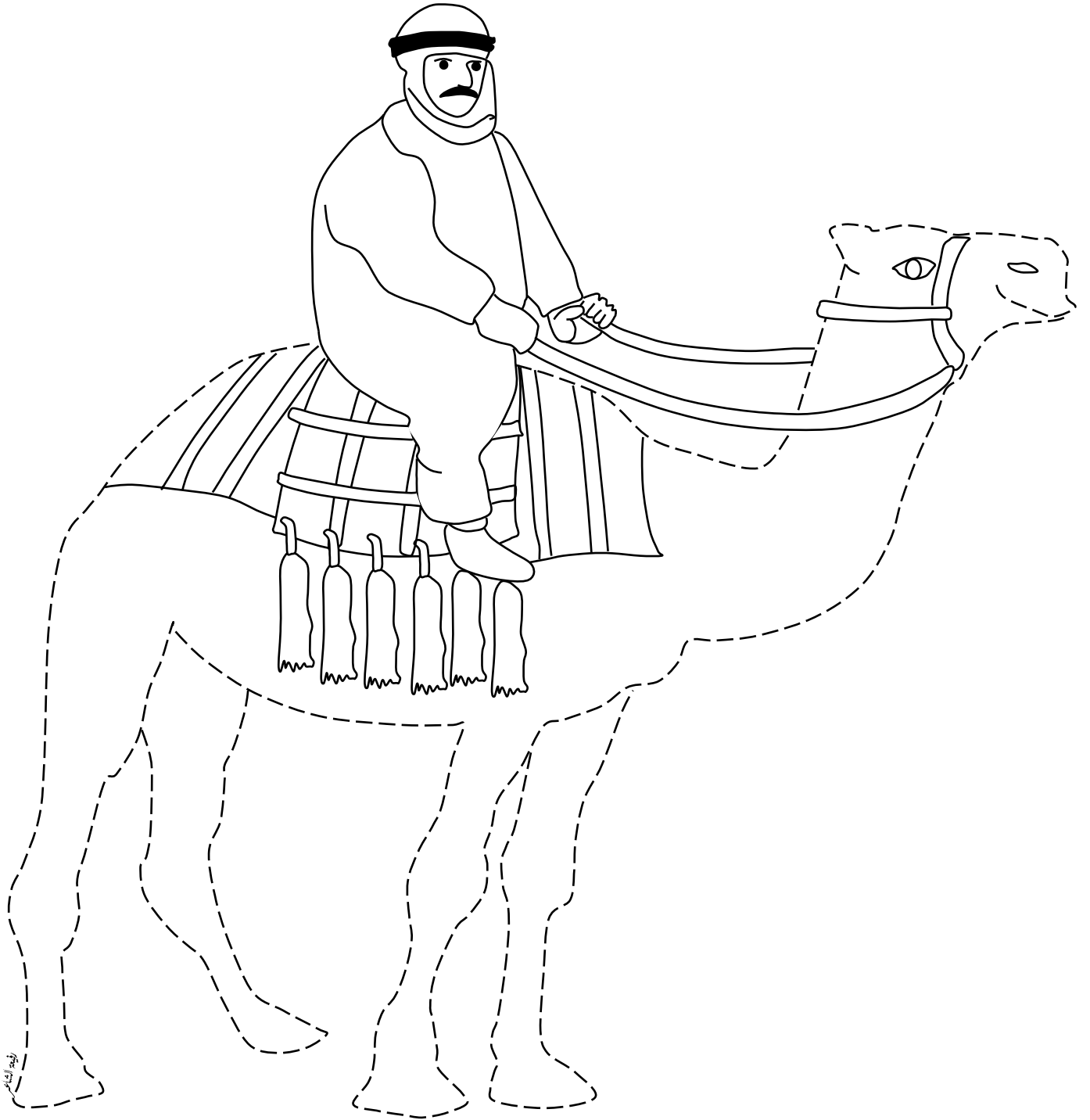

الجمال يساعدنا على التنقل.

أذكر حيوان آخر يساعدنا على التنقل.



فوائد الحيوانات، أخطط وأتعلم.

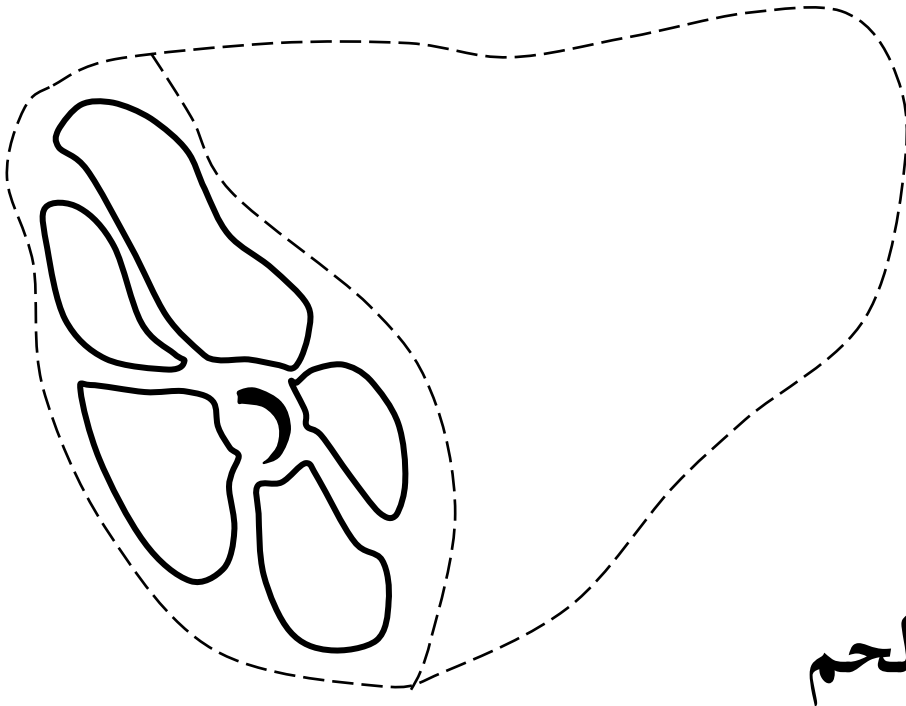
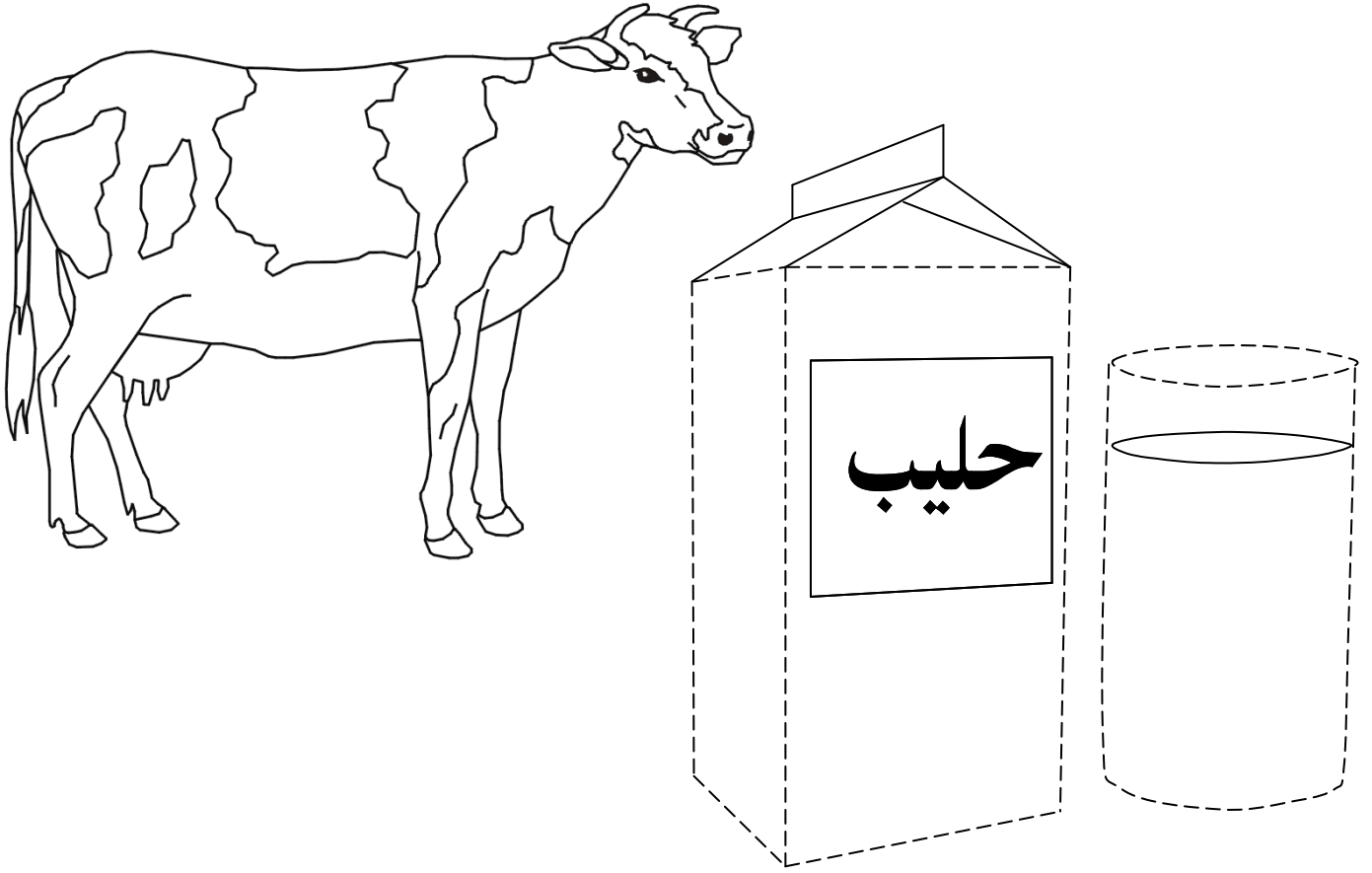

لحم



فوائد الحيوانات، أخطط وأتعلم.

بيض

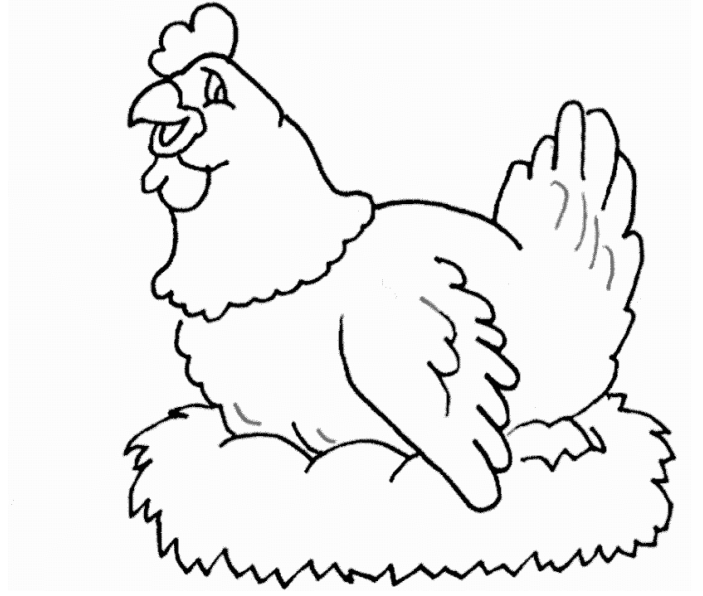
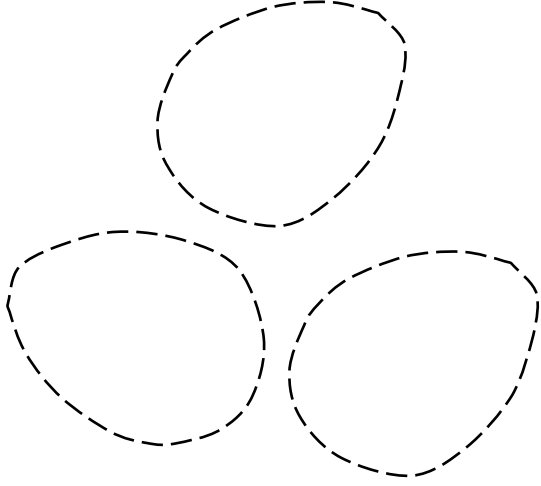

دجاج

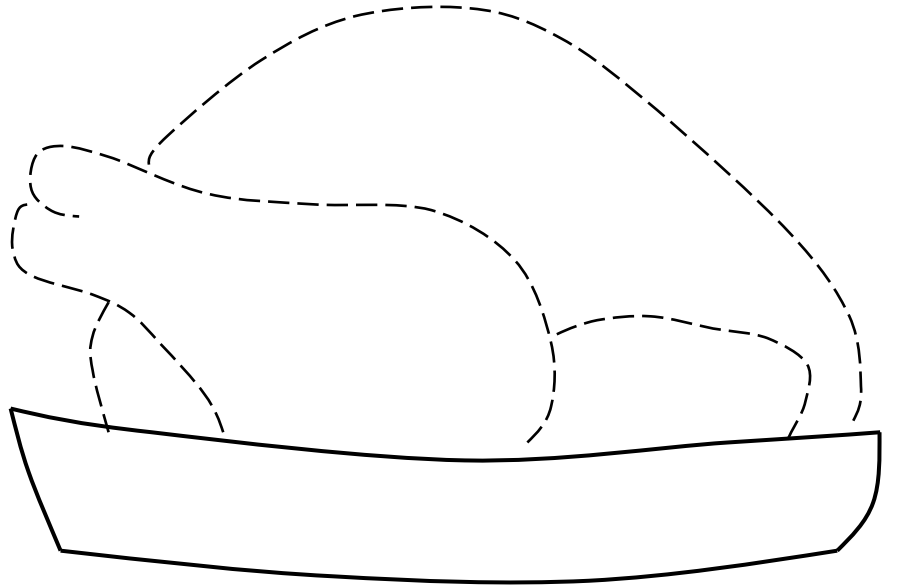

وحدة

الصحراء



أبحث عن حيوانات الصحراء وألونها.

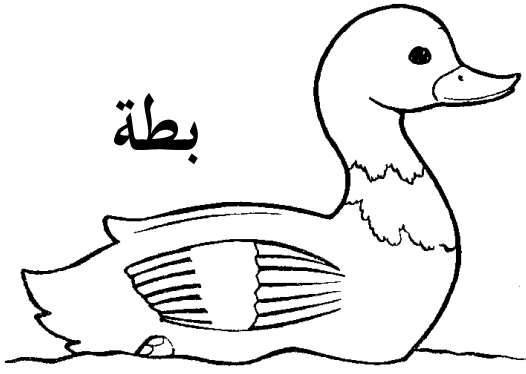

بطة



عقرب



سحلية

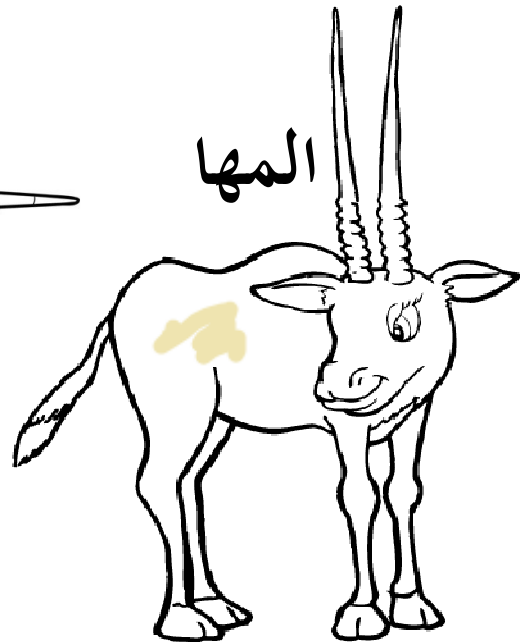

المها

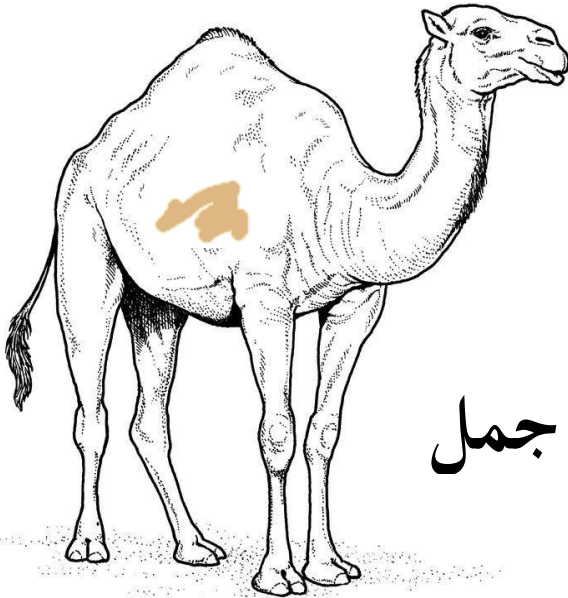

جمل

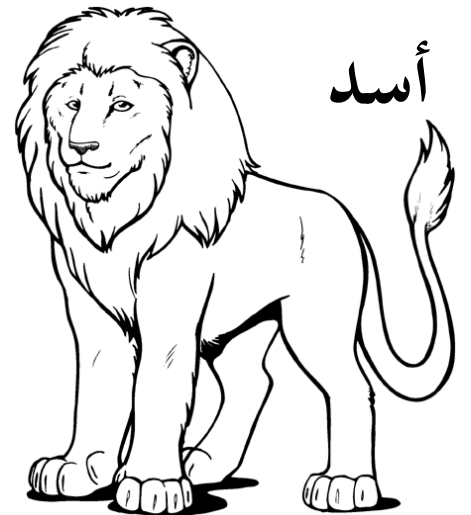

أسد

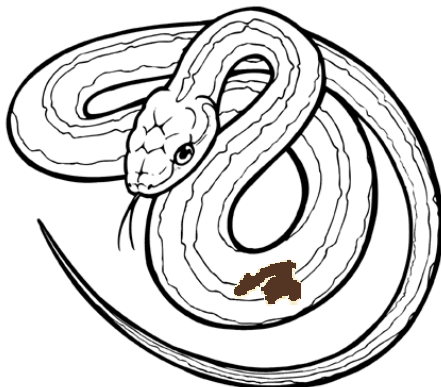

أفعى



الخيمة مسكن البدو، أحوط ما أتوقعه موجوداً في الخيمة.



بدوي

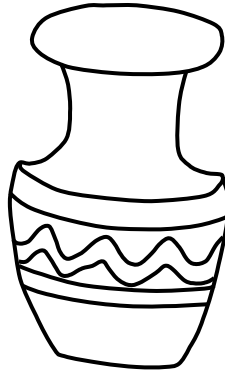

جرّة

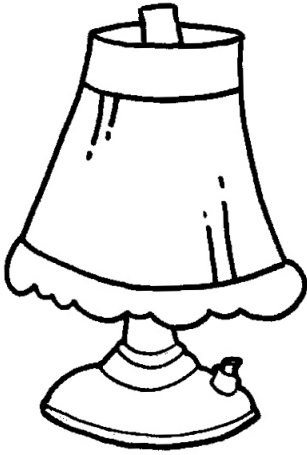

مصباح



فانوس

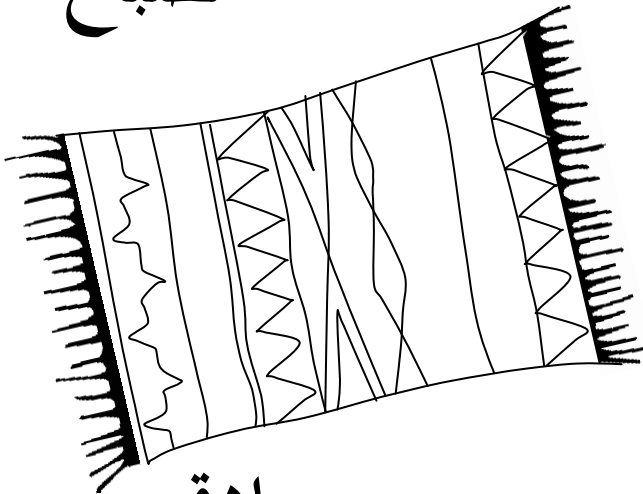

سجادة

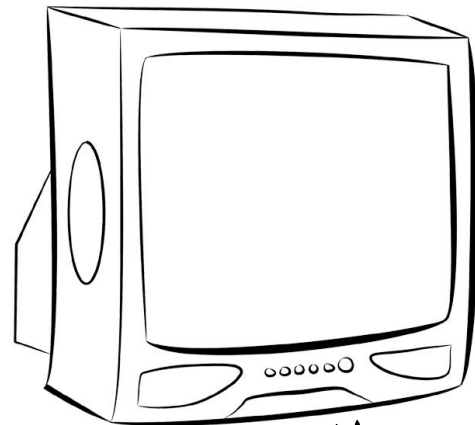

تلفاز



ألون مصادر الماء في الصحراء.

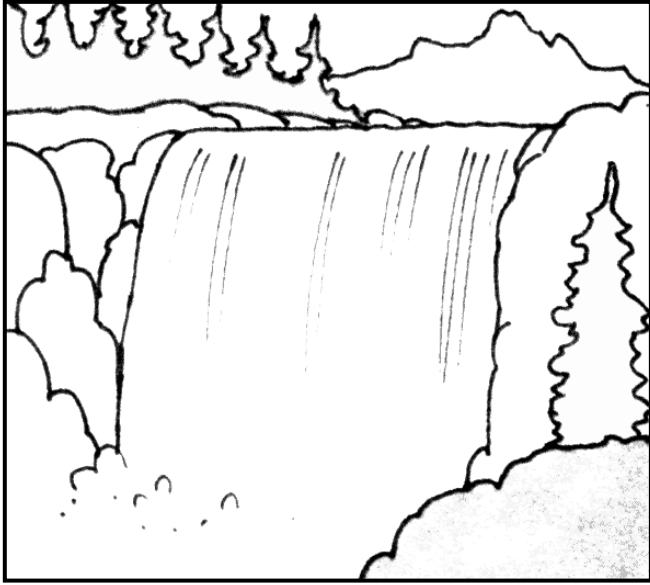

شلال

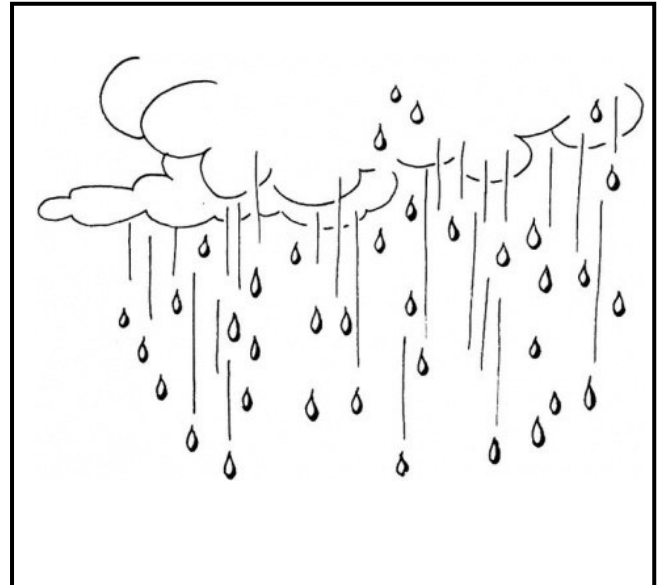

أمطار

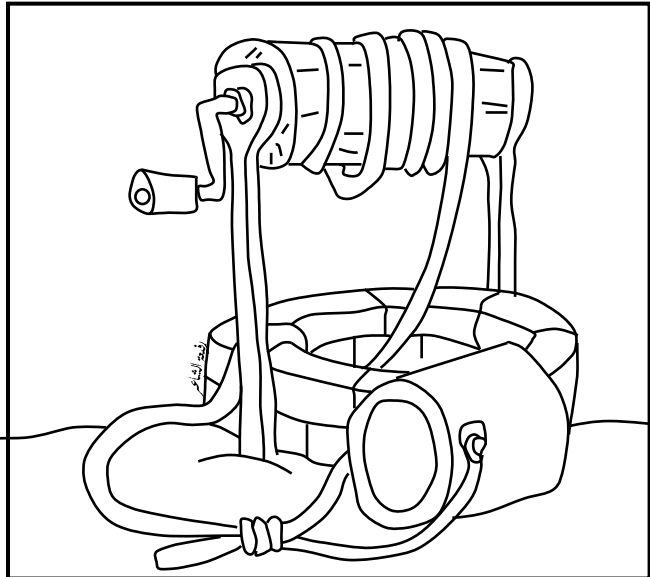

آبار جوفية

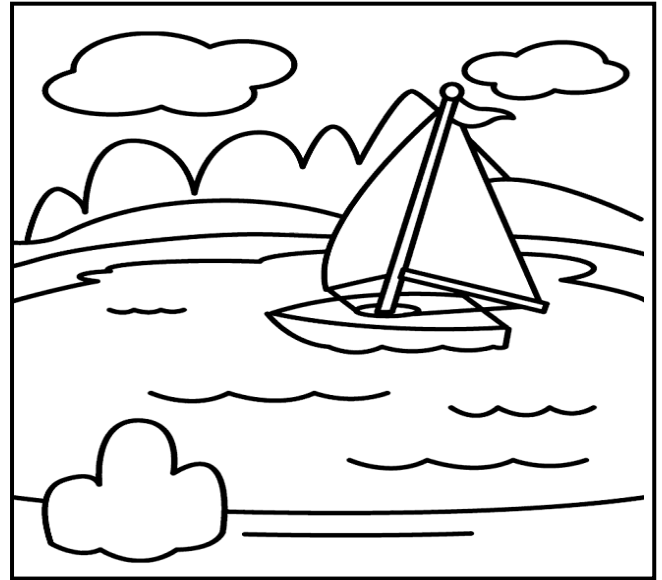

بحيرة



أتعرف على بعض نباتات الصحراء، وألونها.

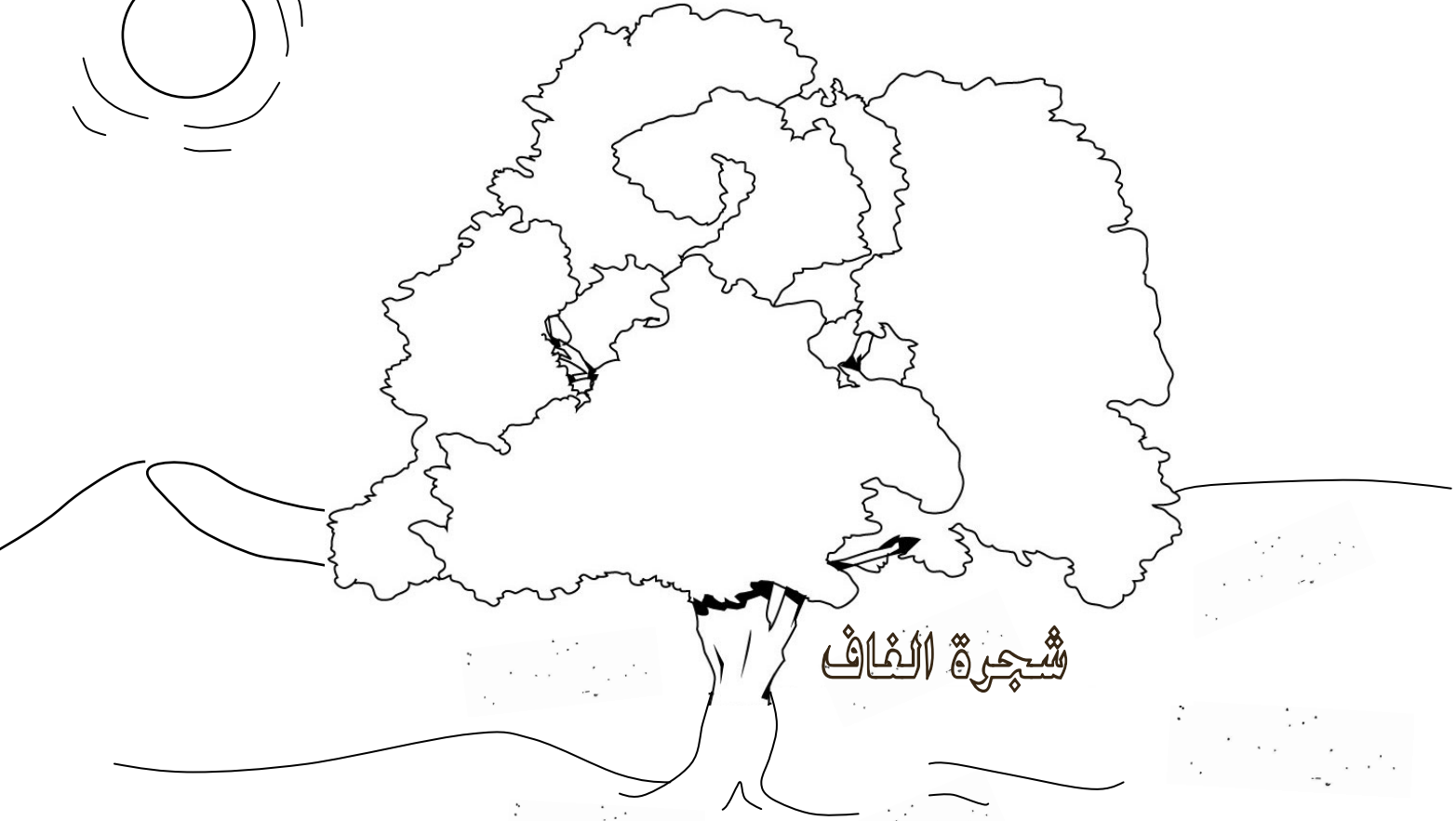
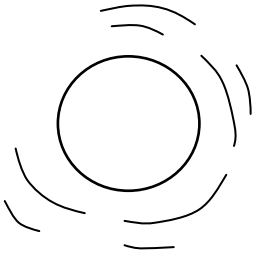

شجرة النخاف

الحوذان



الصبار



الحميض



أصل الراعي إلى أغنامه.

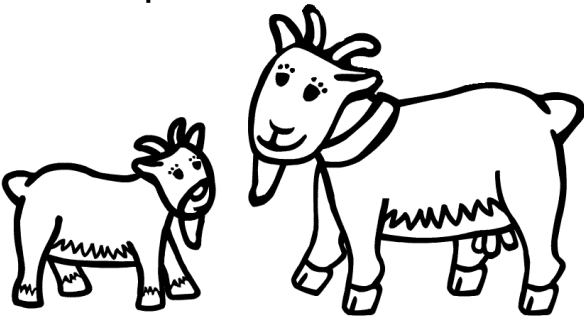
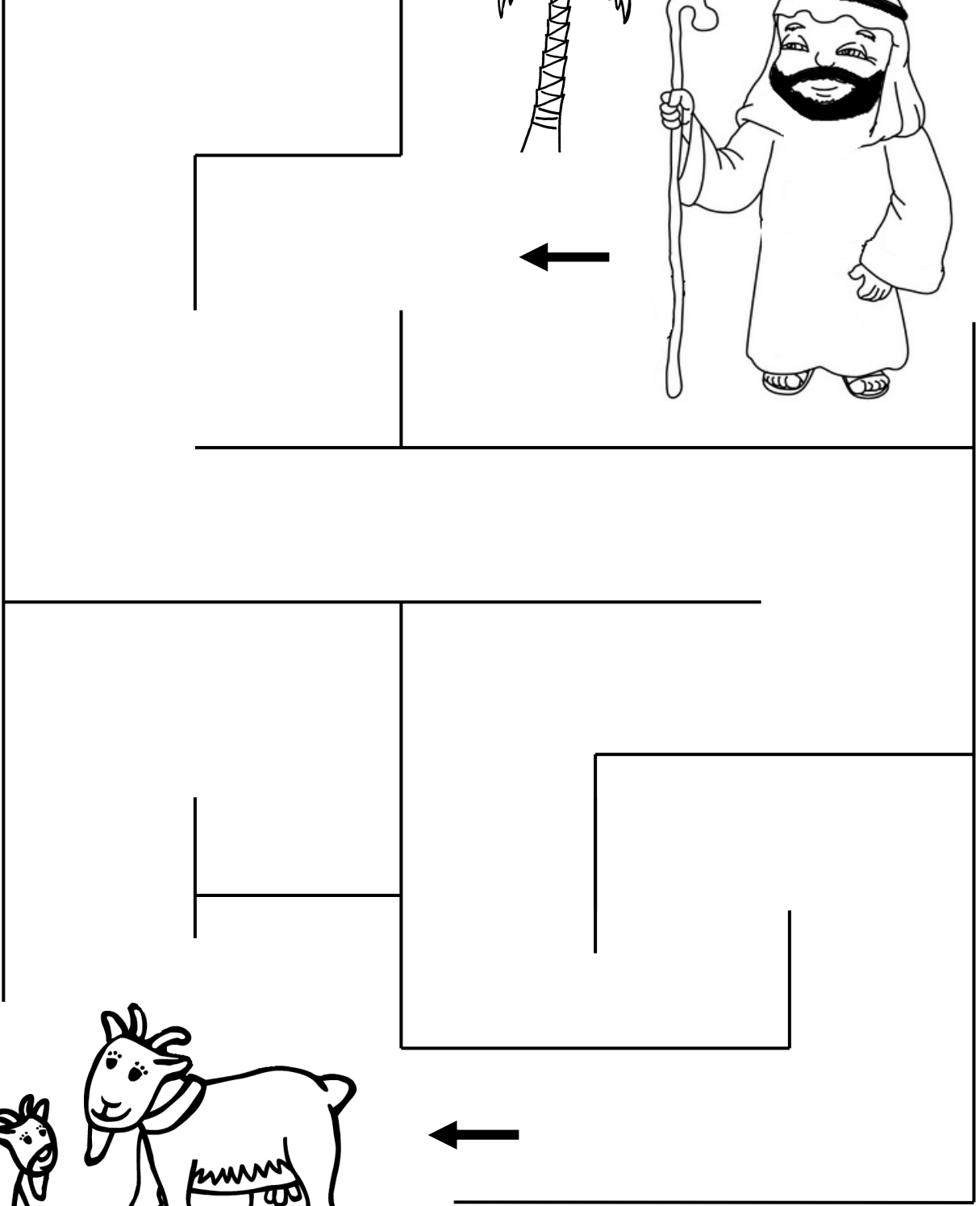
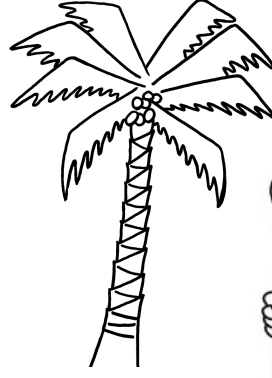

" قديم ، حديث " أحوط ما هو قديم.

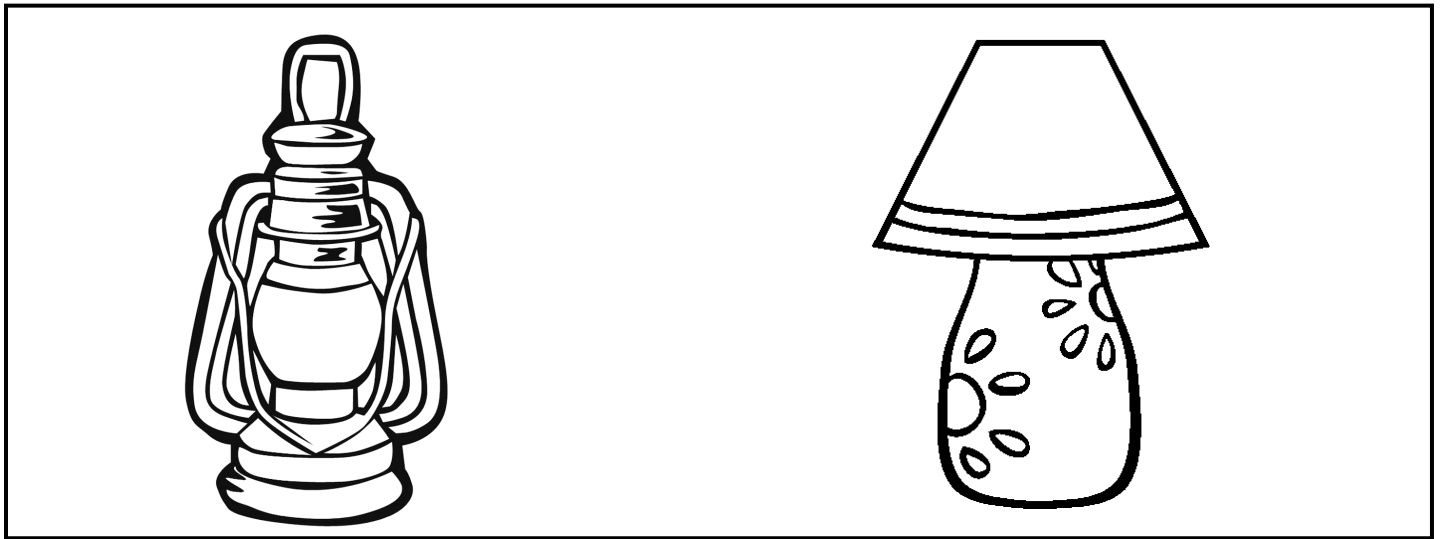
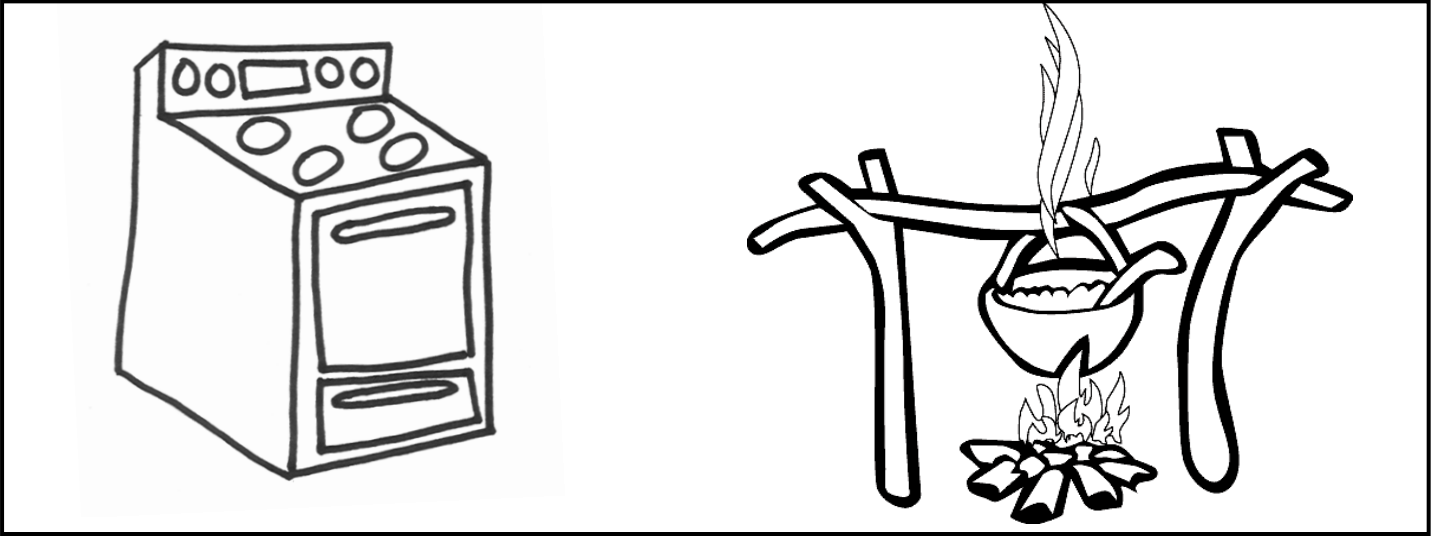
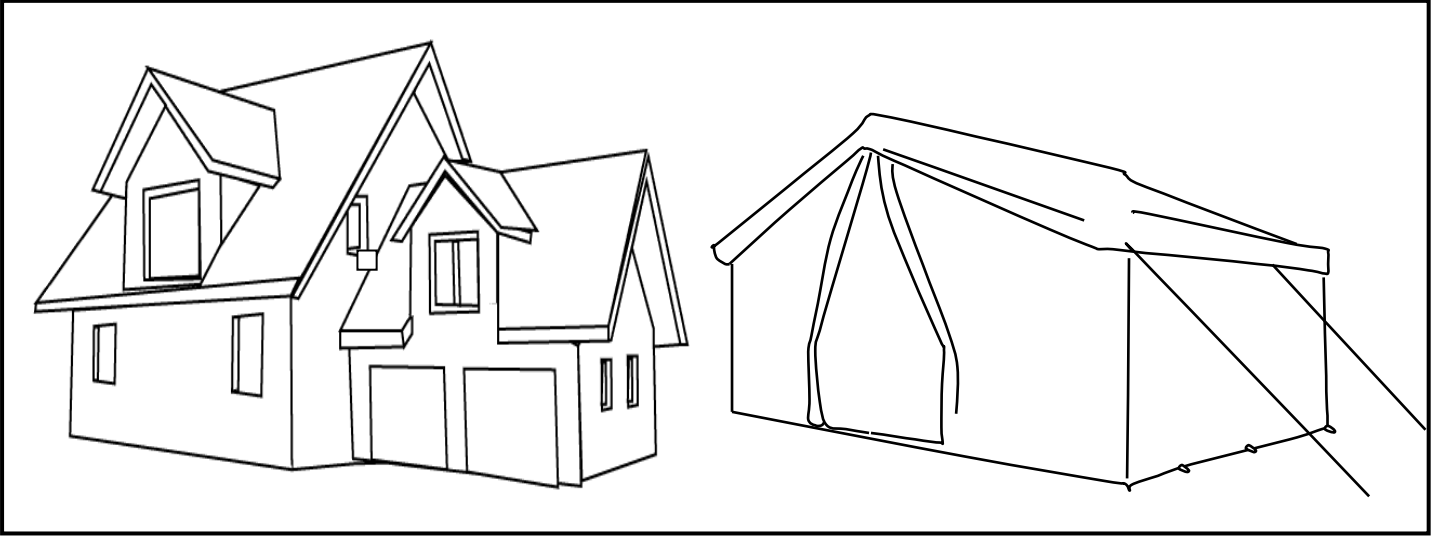

حياة البدو في الصحراء، ألون.

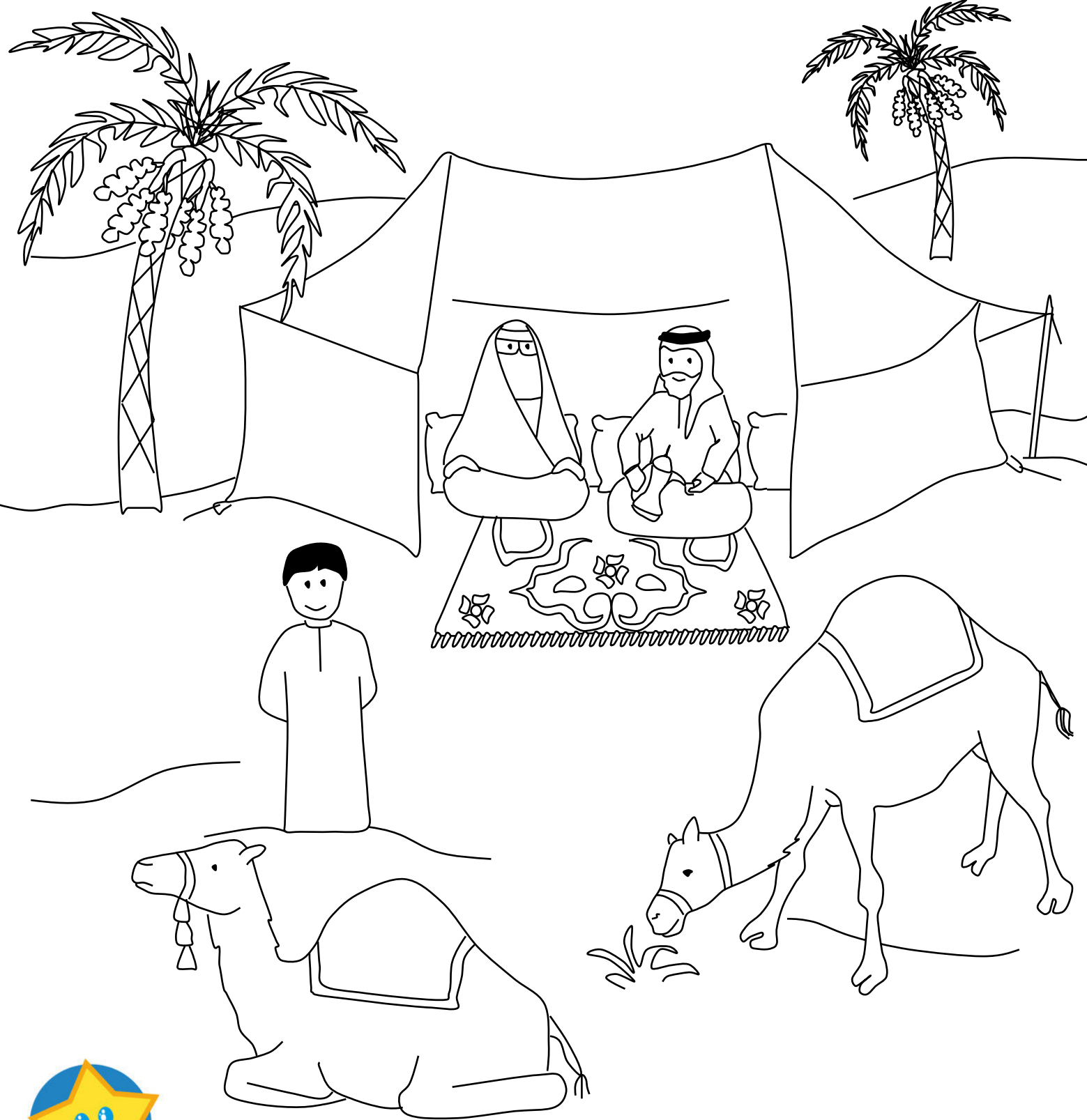
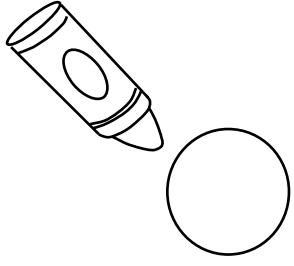

وحدة

الحج



الحج



63

www.Cryp2Day.com

مذكرات جاهزة للطباعة

وحداتي

الحج ركن من أركان الإسلام.

الحج

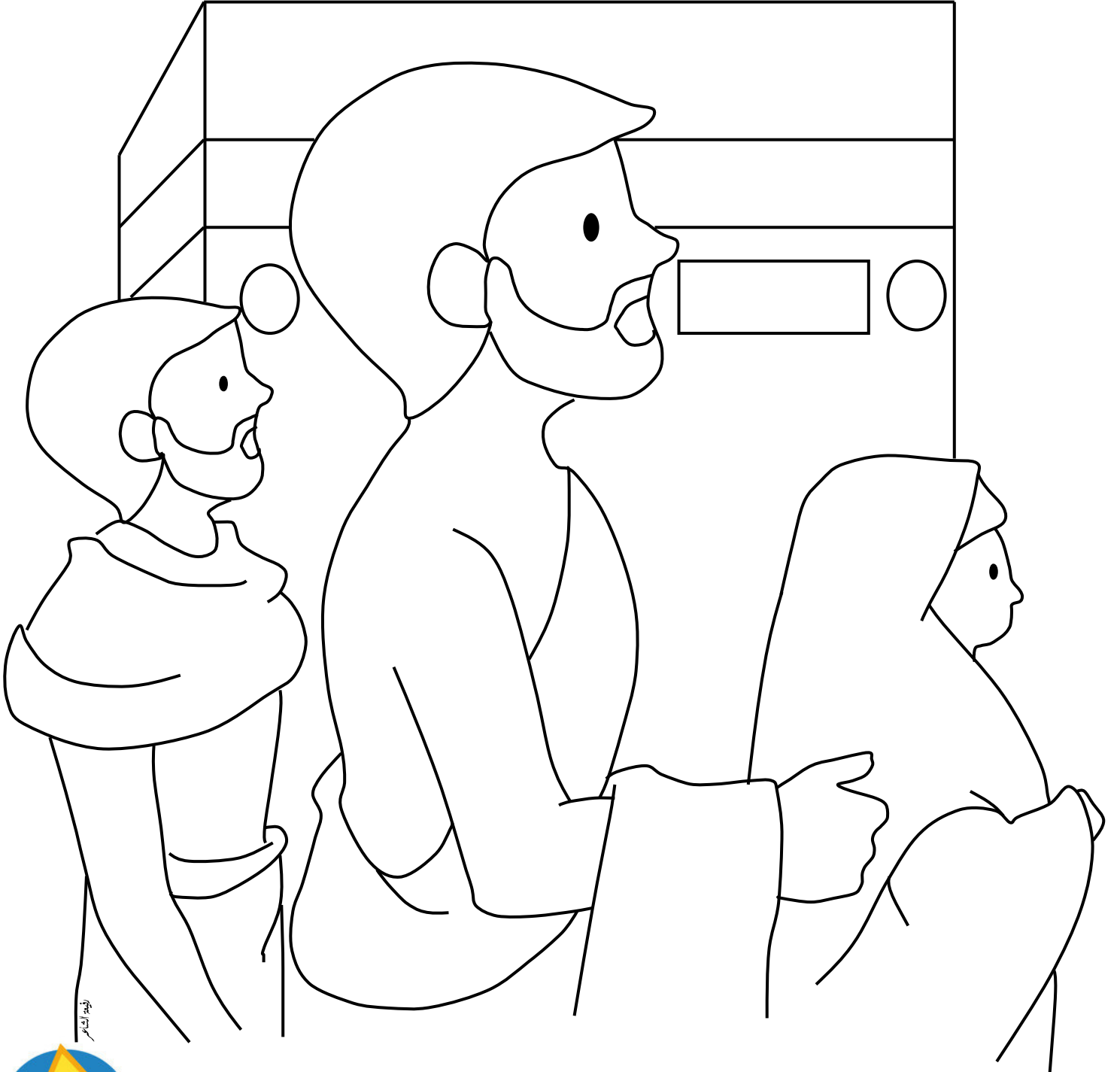

كيف يمكن للحجاج السفر لأداء فريضة الحج. أحوط الوسيلة المناسبة.

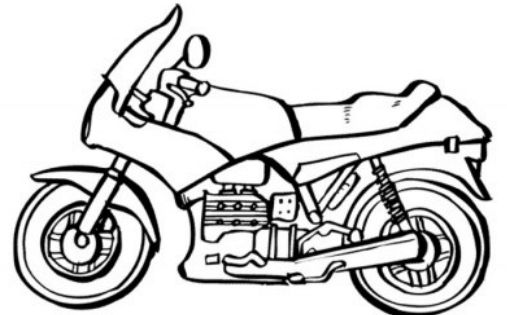
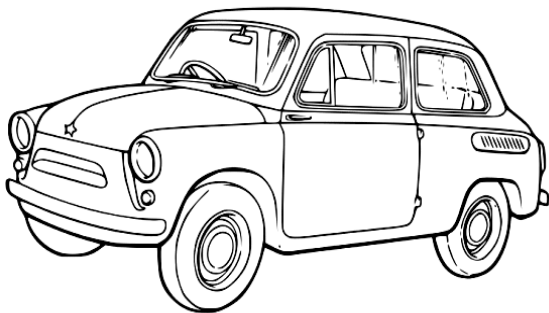
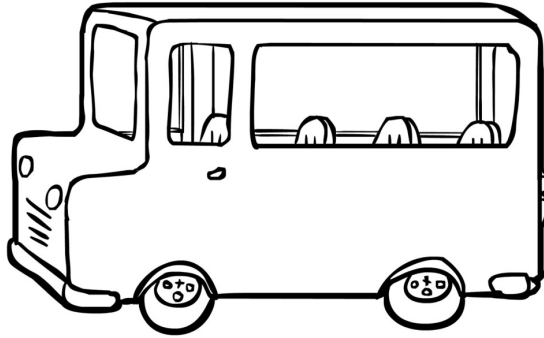
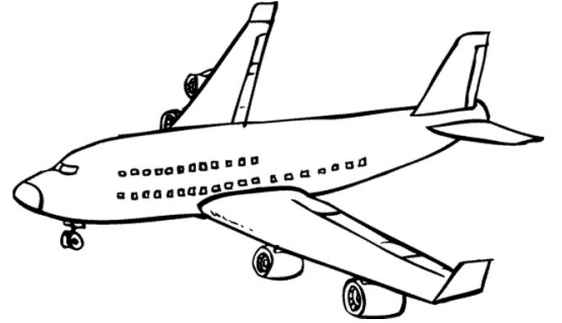
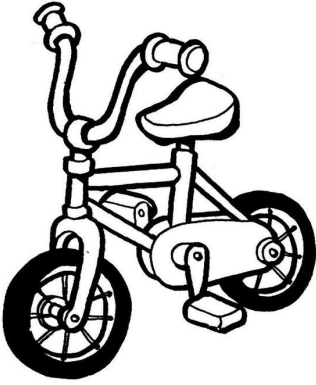
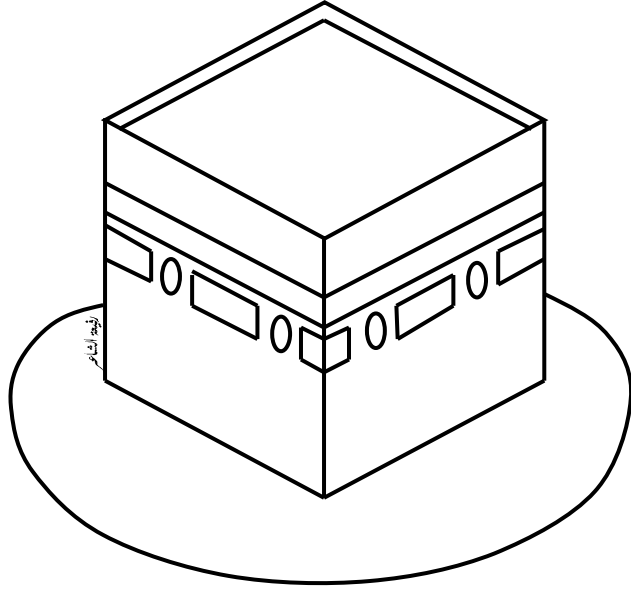

أتعرف على بعض مفردات مناسك الحج. أقرأ و ألون.

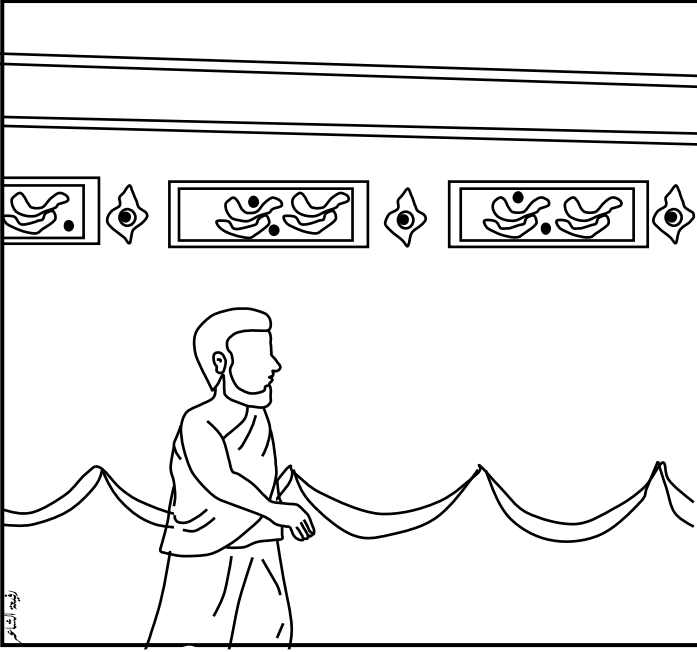

الطواف حول الكعبة

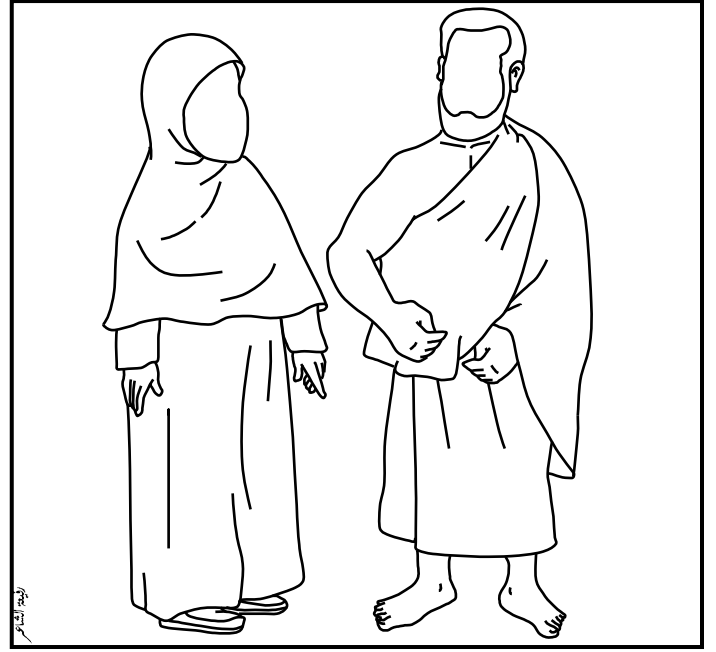

الإحرام

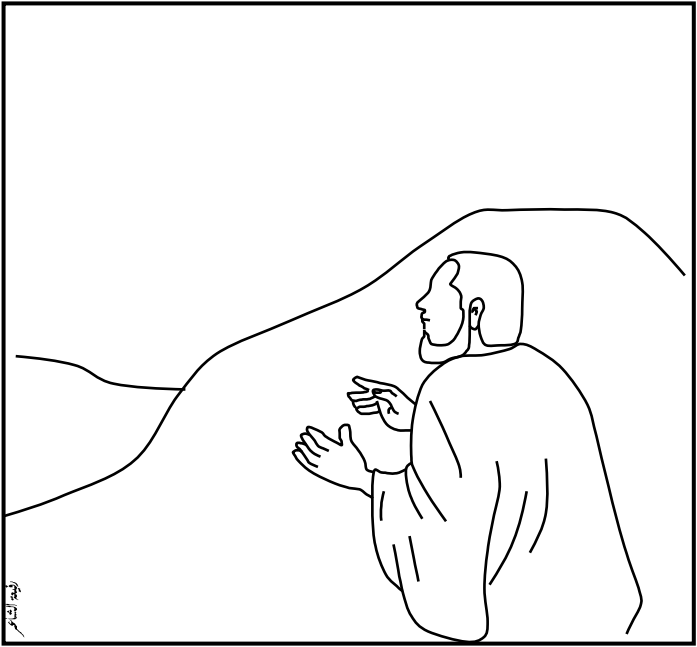

الوقوف بعرفة

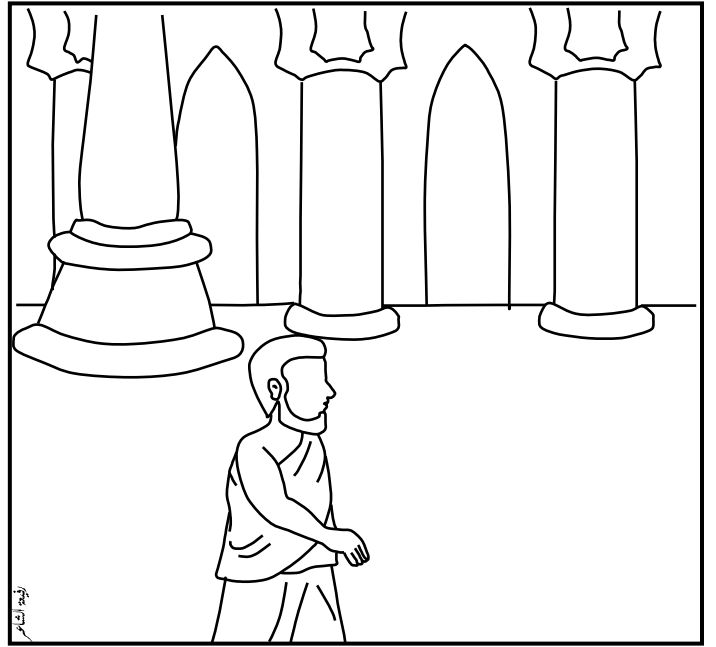

السعي بين الصفا والمروة



أتعرف على بعض مفردات مناسك الحج. أقرأ وألون.

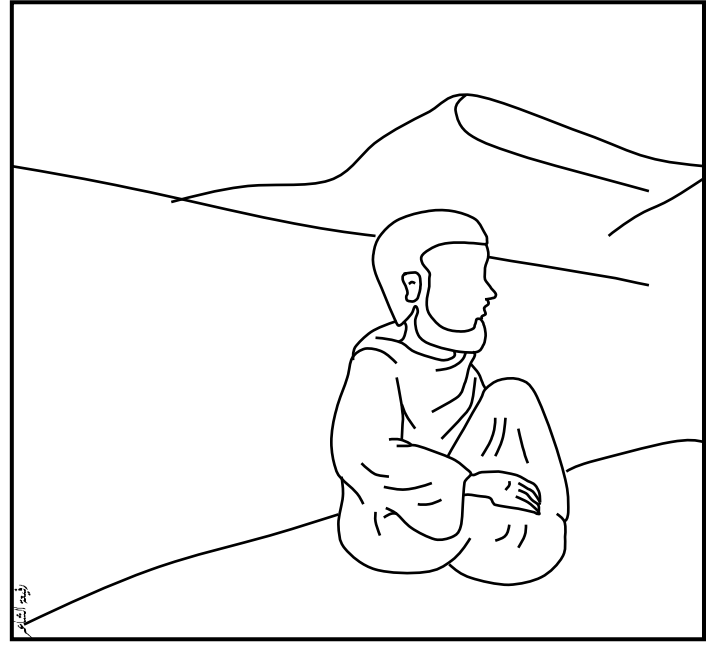
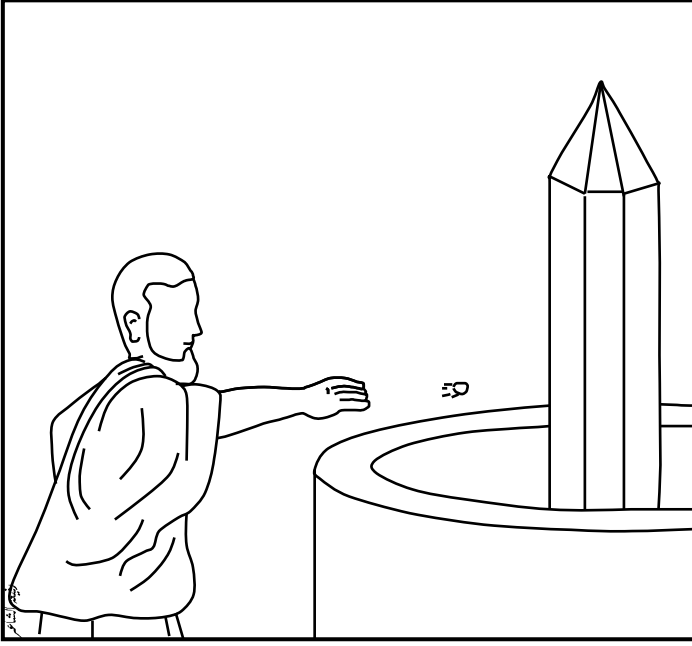

رمي الجمرات

المبيت في مزدلفة

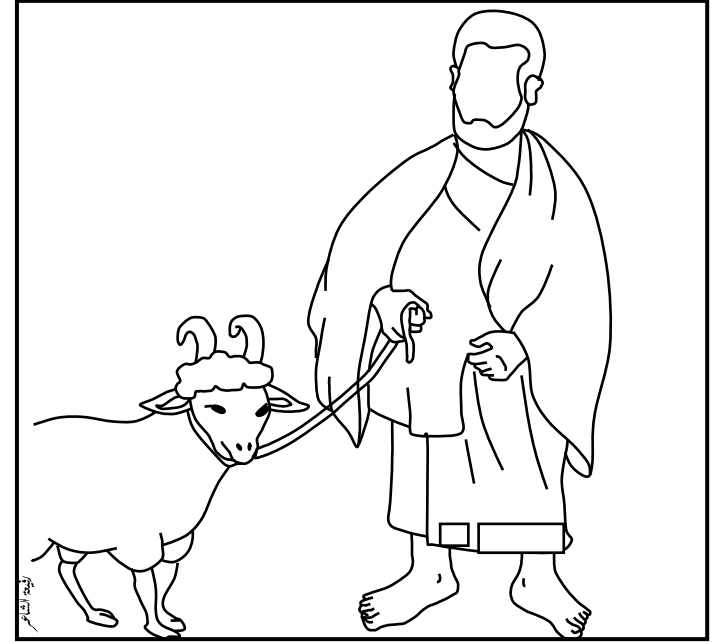
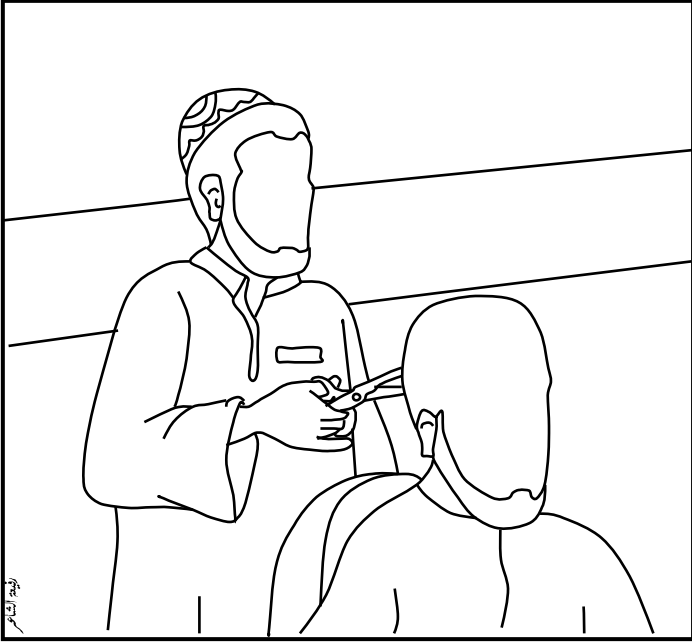

حلق الرأس

نحر الأضاحي



أحوظ مظاهر الاحتفال بالعيد.



نقش الحنا



الرقصات الشعبية



الذهاب للمدرسة

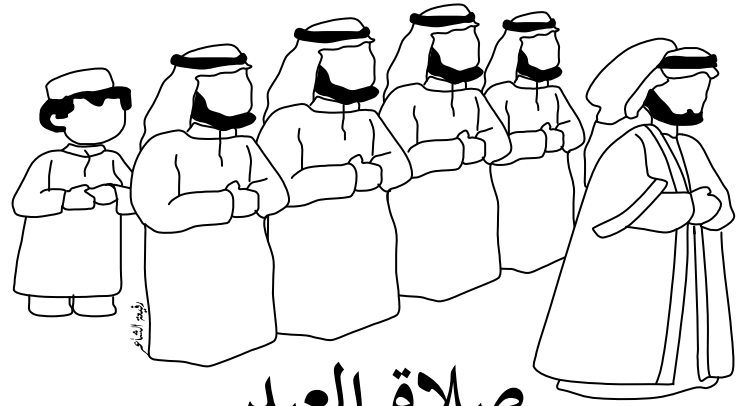

صلاة العيد

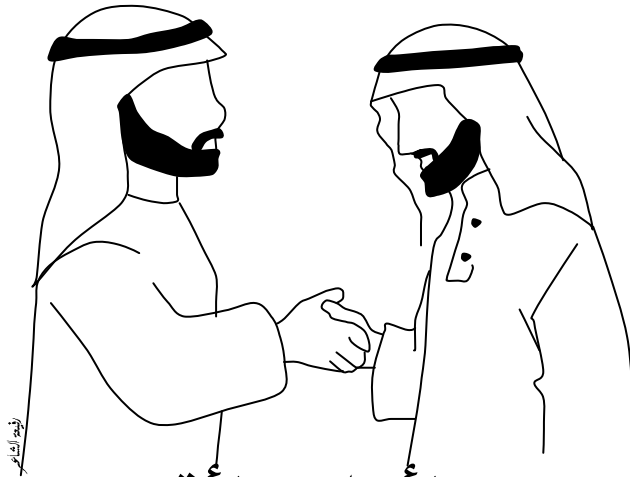

زيارة الأهل والأقارب



صيد السمك





وحدة

النباتات



احتياجات النباتات، أصل النبتة باحتياجاتها.

ضوء الشمس

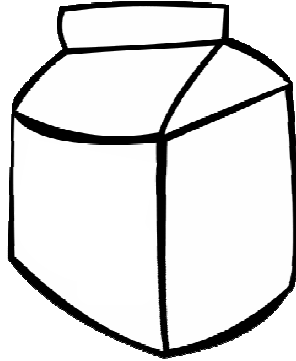
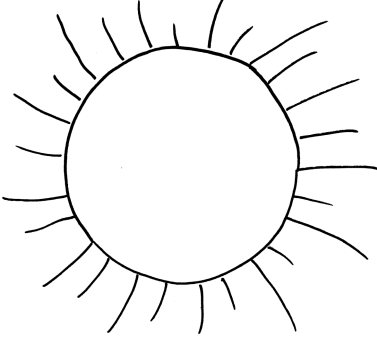

حليب

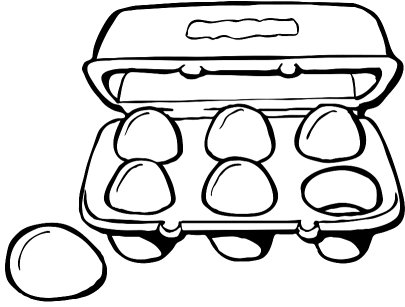
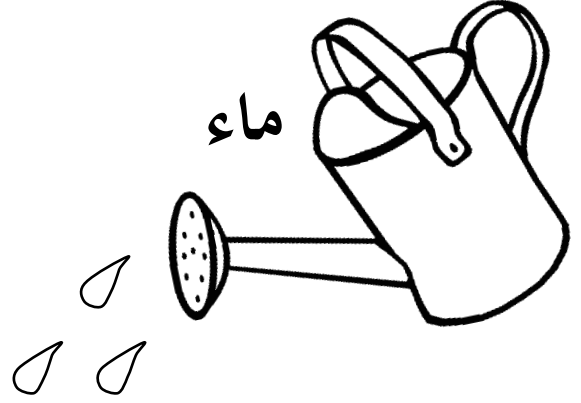

بيض

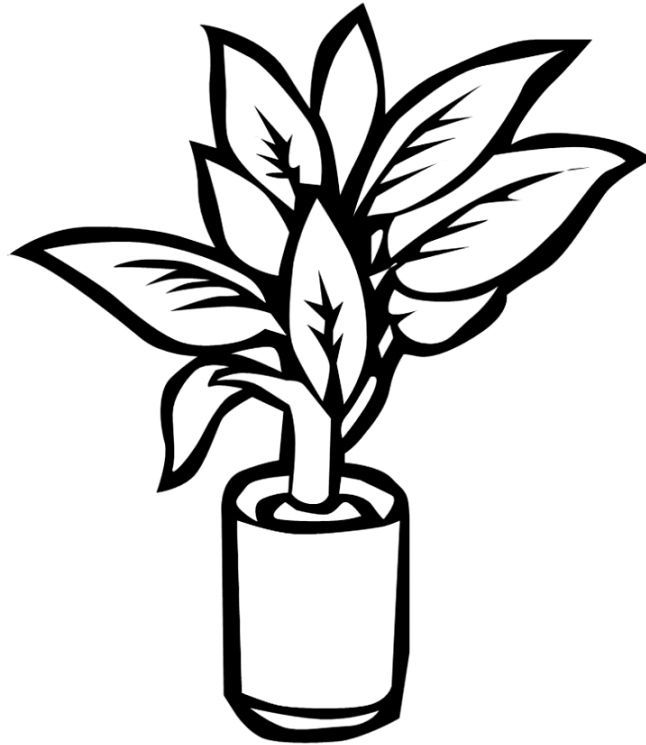
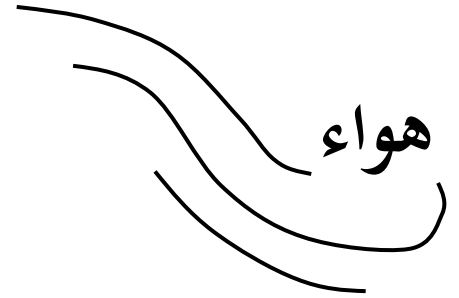

للنباتات فوائد، ألون فائدة كل نبات.

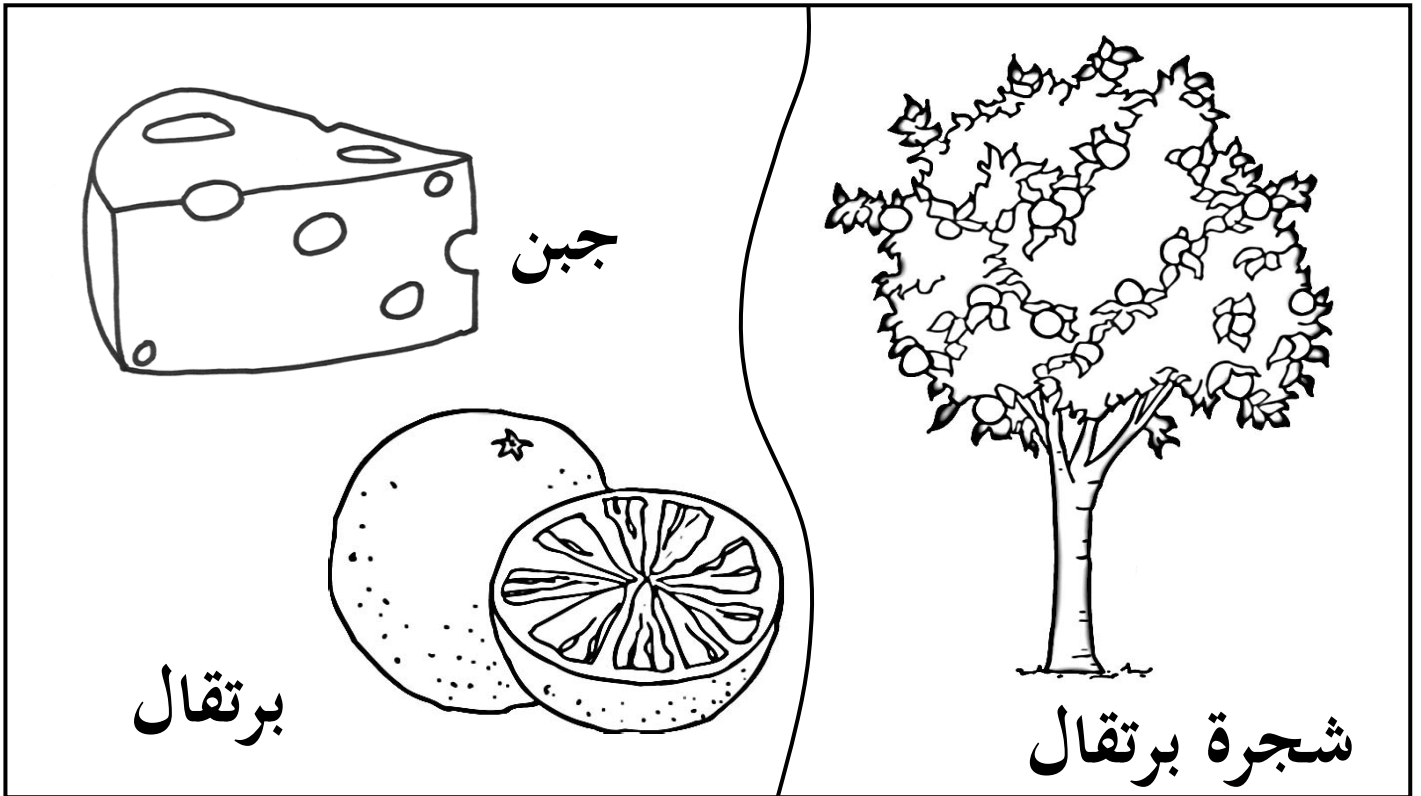
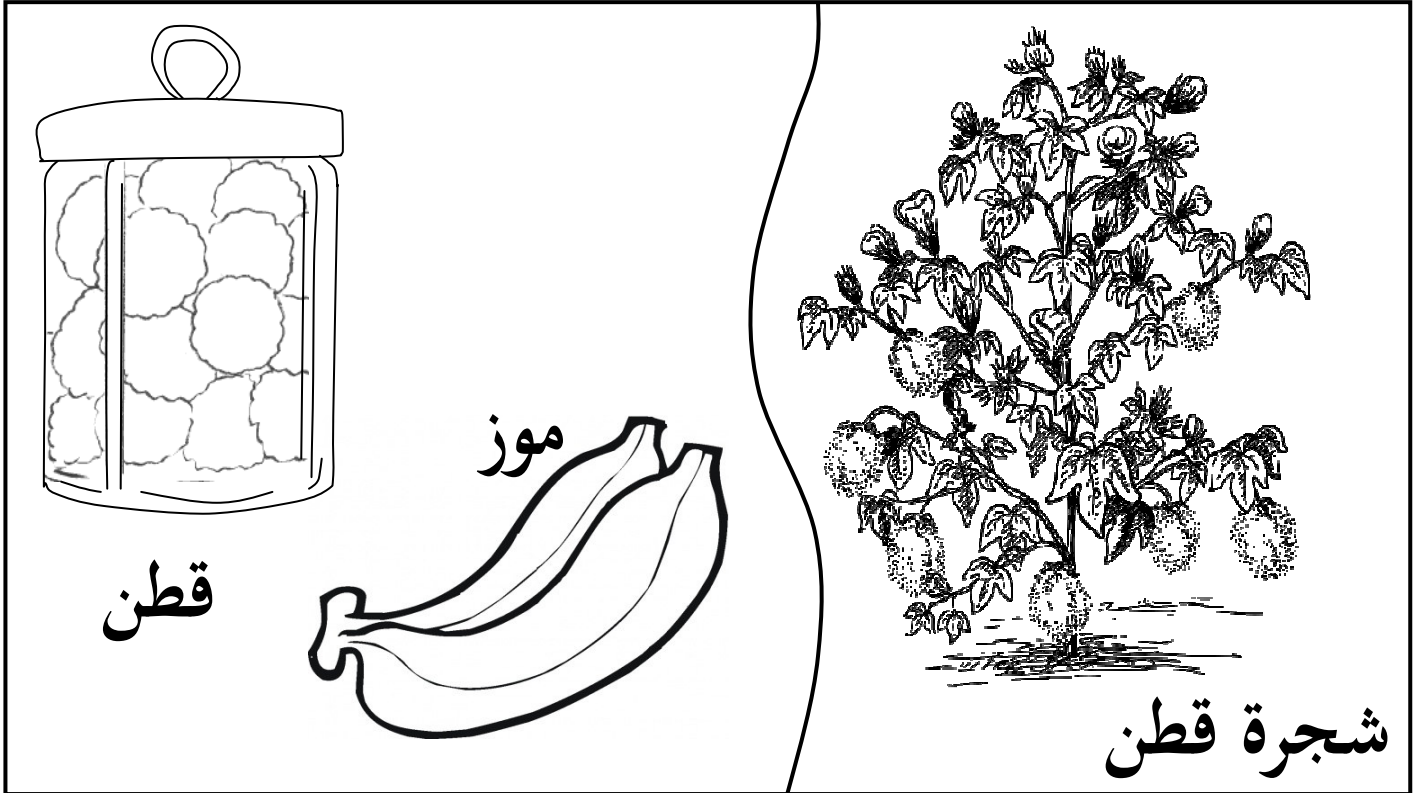

للنباتات فوائد، ألون فائدة كل نبات.

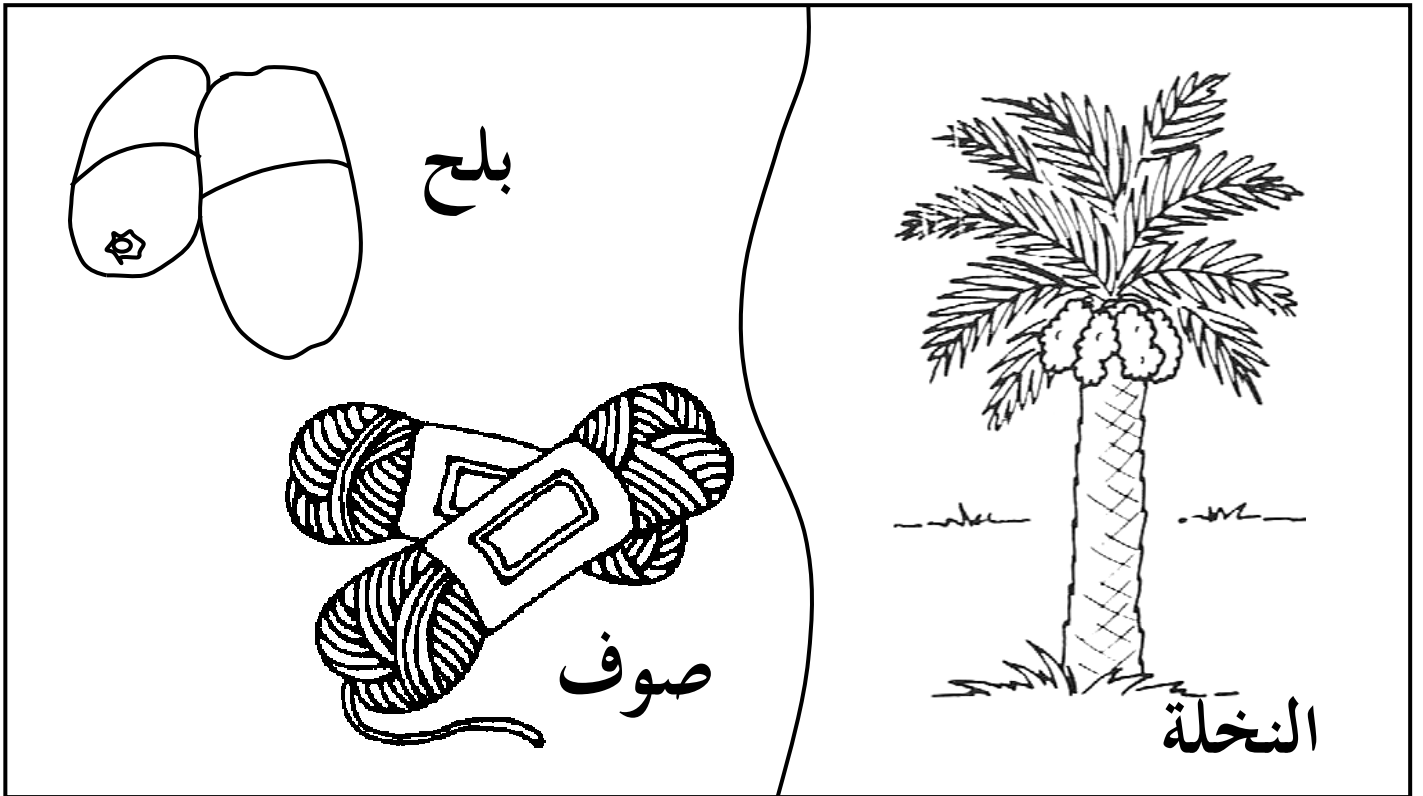

الأزهار مختلفة، أطابق وأصل.

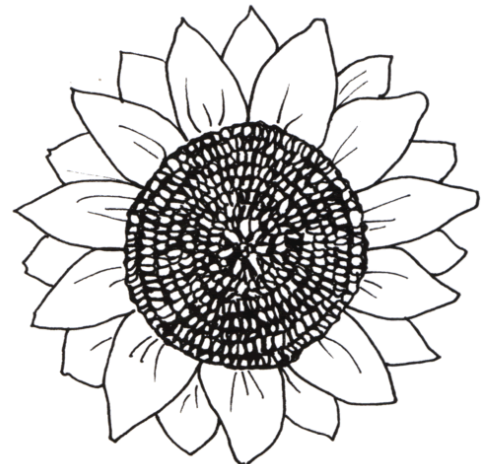
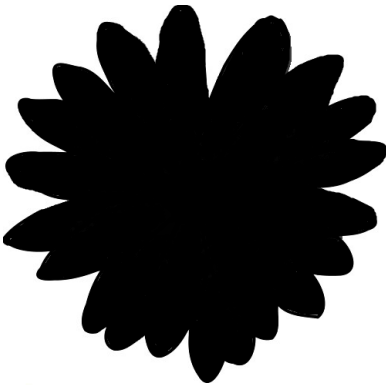
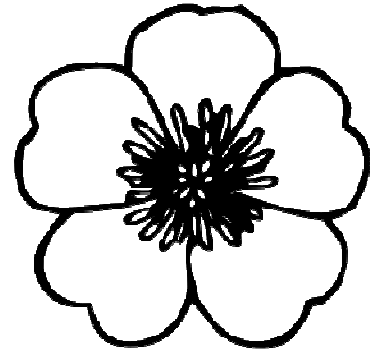
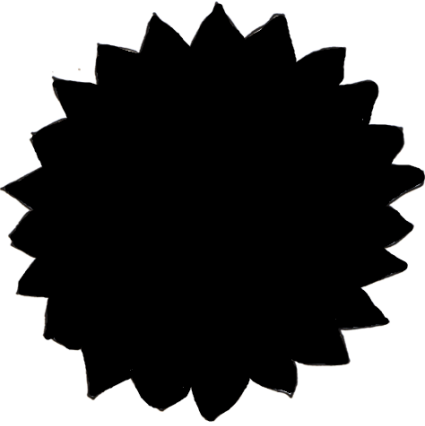
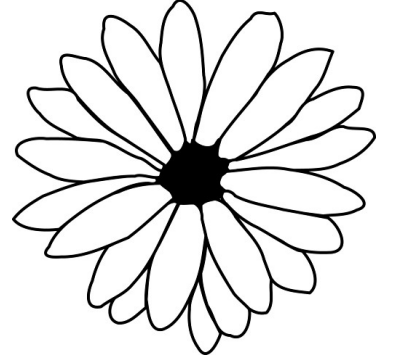
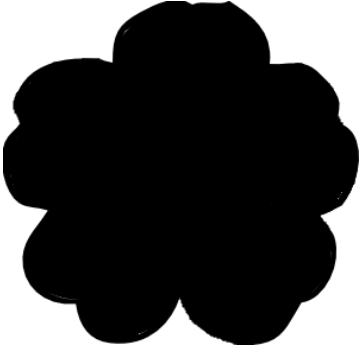



وحدة

الماء



استعمالات الماء، أرسم قطرات الماء وألّون.



اطفاء الحريق

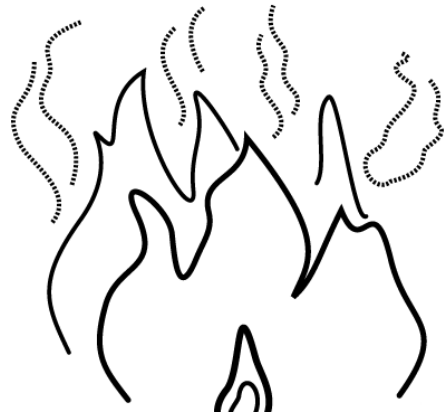

ري المزروعات



استعمالات الماء، أرسم قطرات الماء وألّون.



الوضوء

السباحة



أتعرف على مصادر المياه، أكتب وأصل.

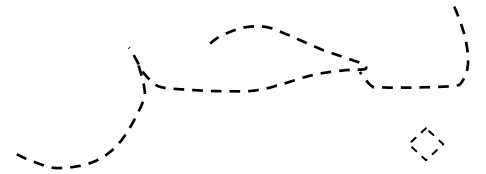
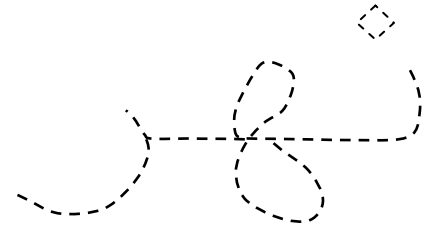
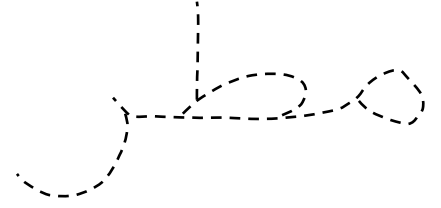
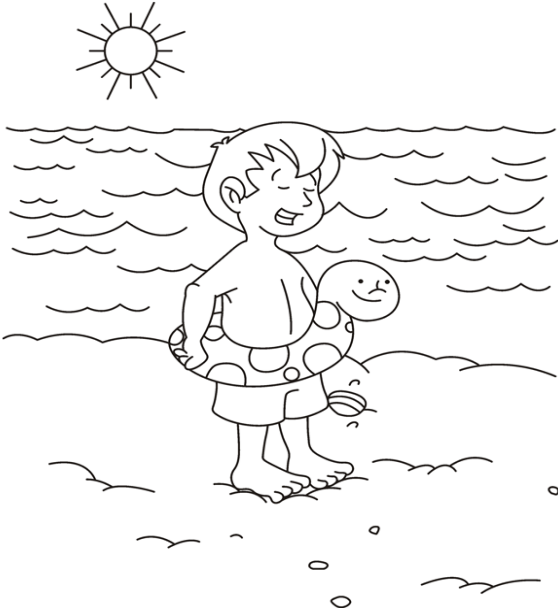

الرياضات المائية كثيرة، أطبق وأصل.

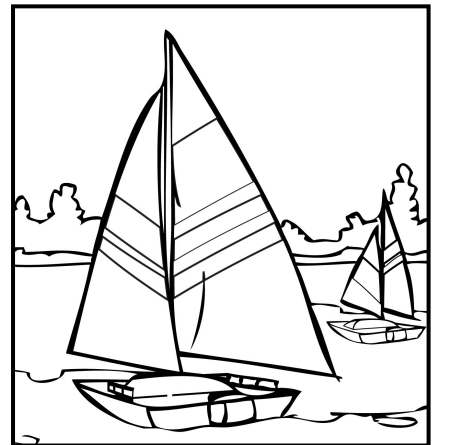
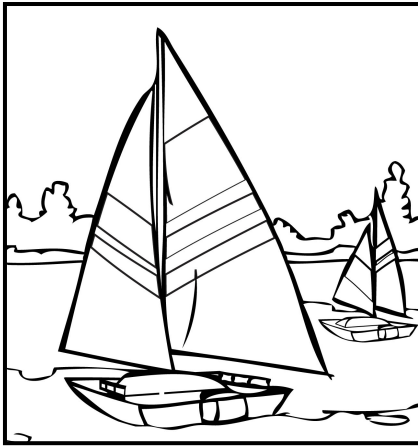
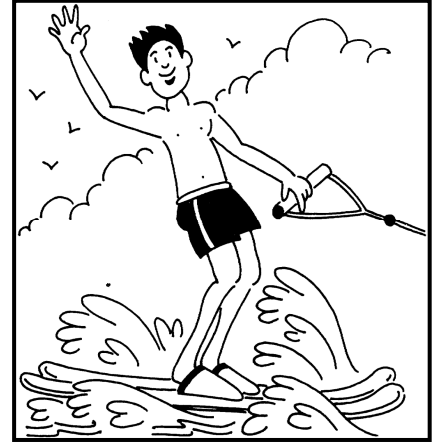
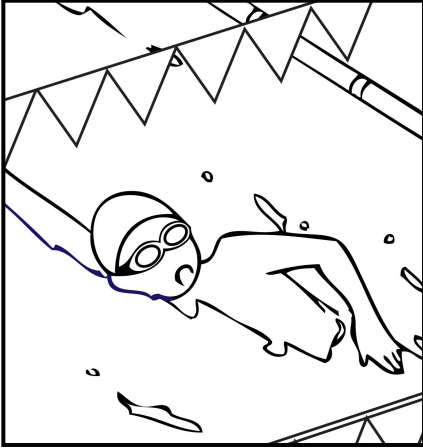

أرسم وألّون ، تكوّن دورة الماء في الطبيعة.

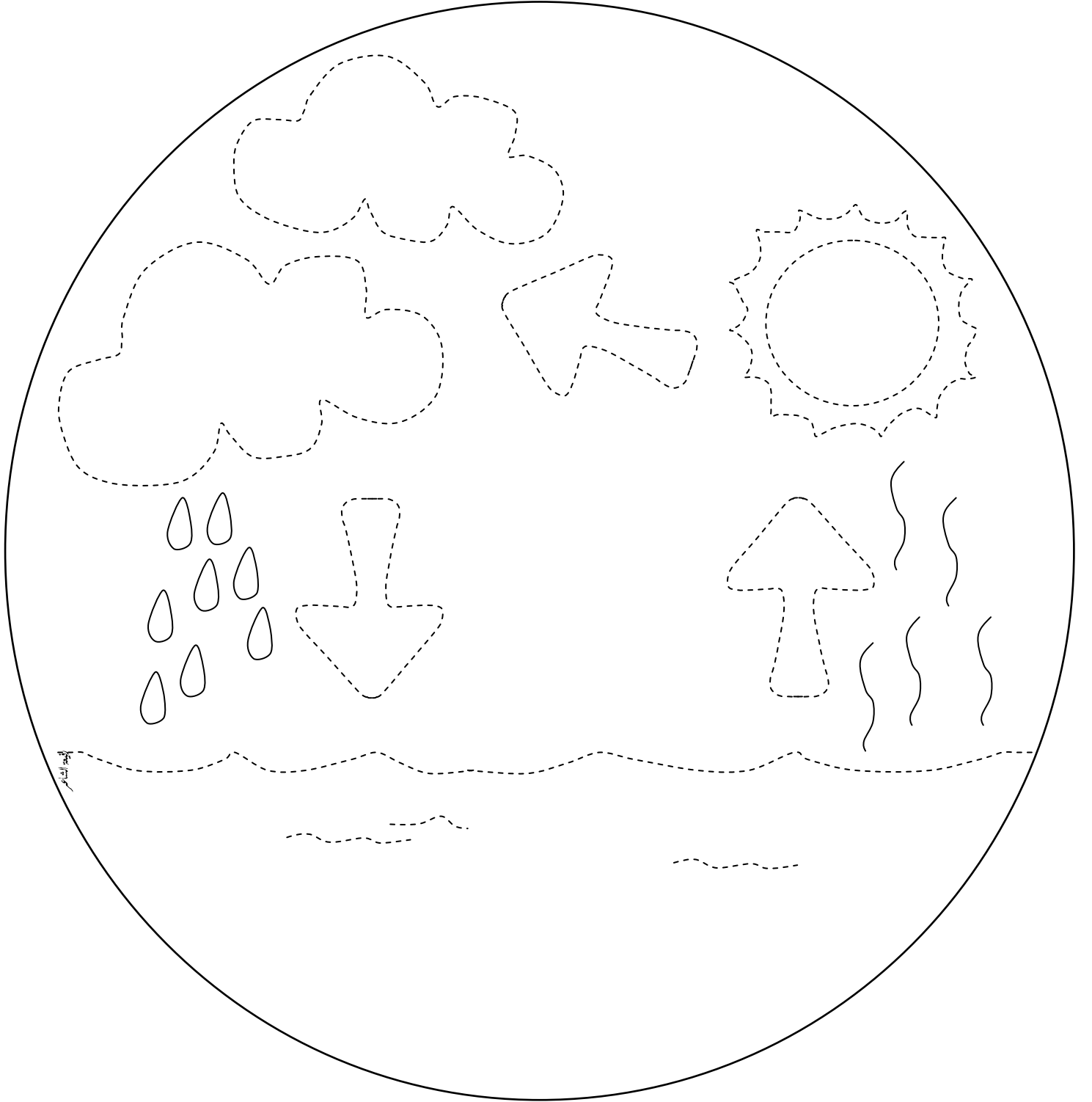

وحدة

المواصلات



أحوط وسائل المواصلات قديماً.



أبحث عن ثلاثة أشياء يستخدمها الإطفائي وأحوظها.

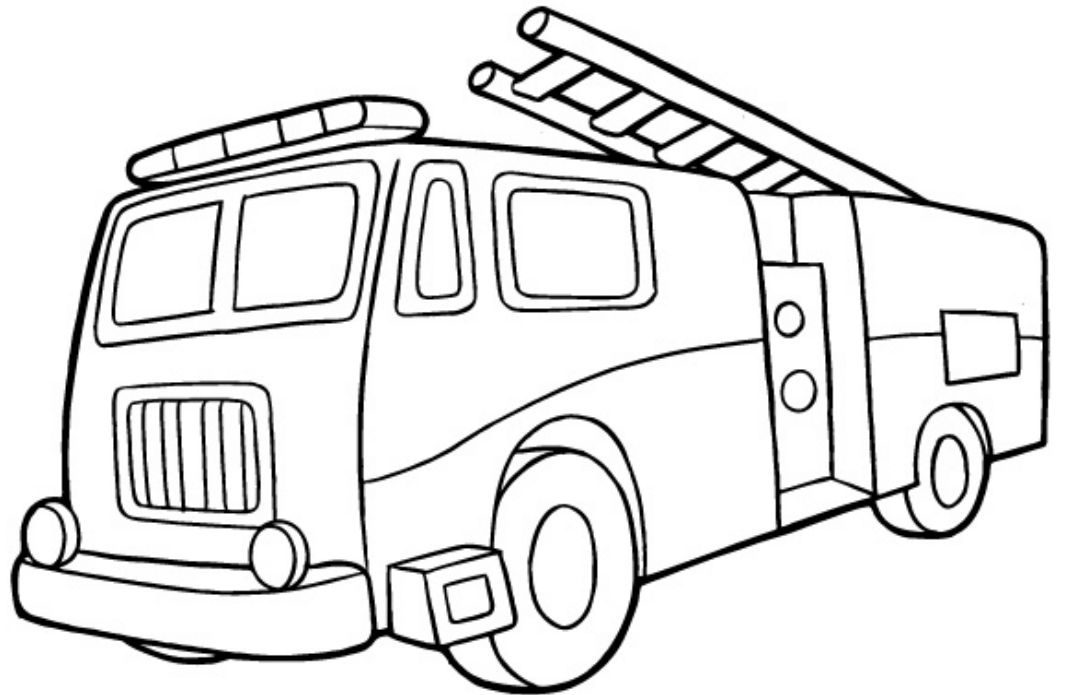
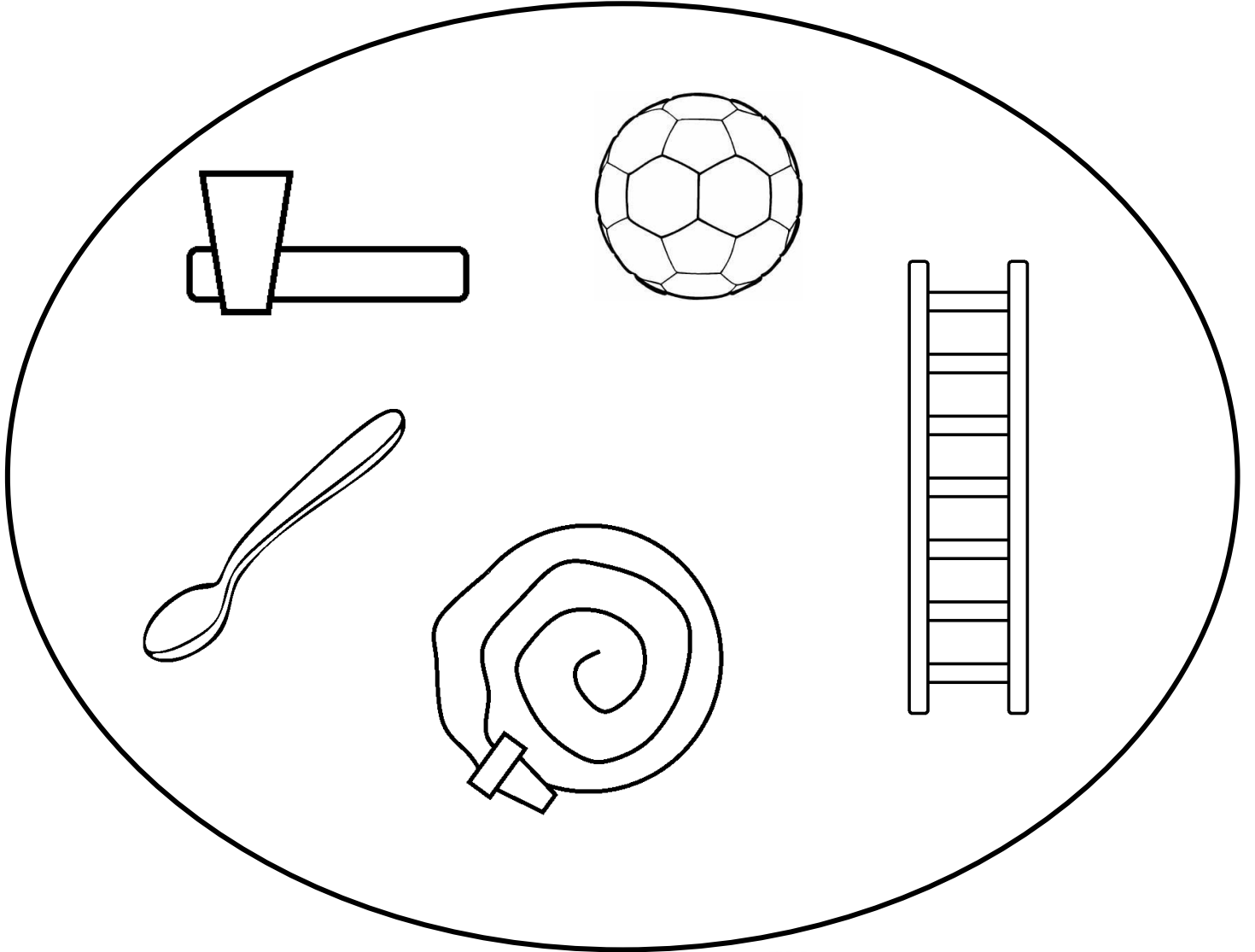

أصل كل شخص إلى مركبته الصحيحة.

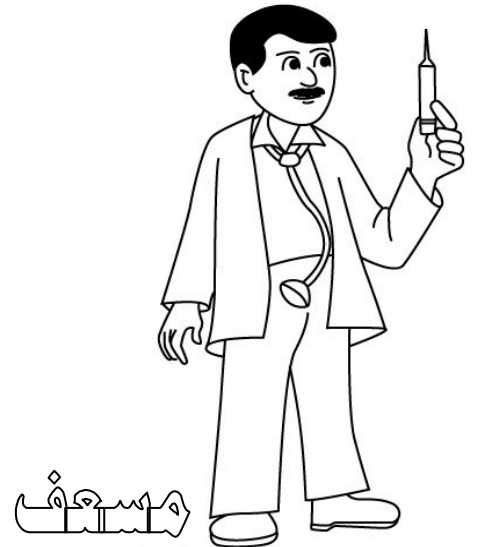
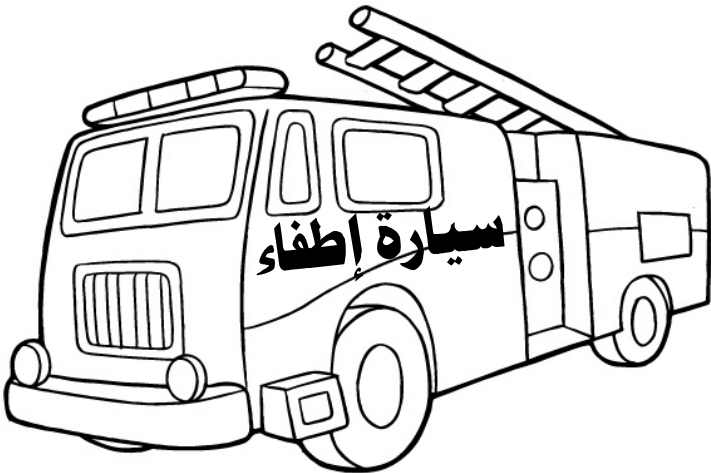
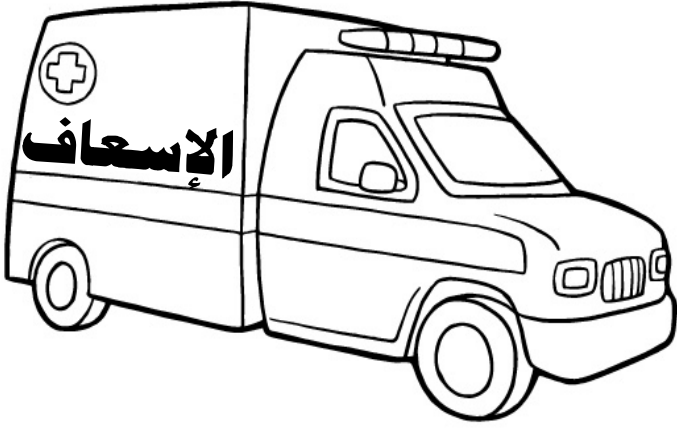

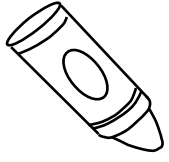

ألوان إشارة المرور.

قف

استعد

انطلق

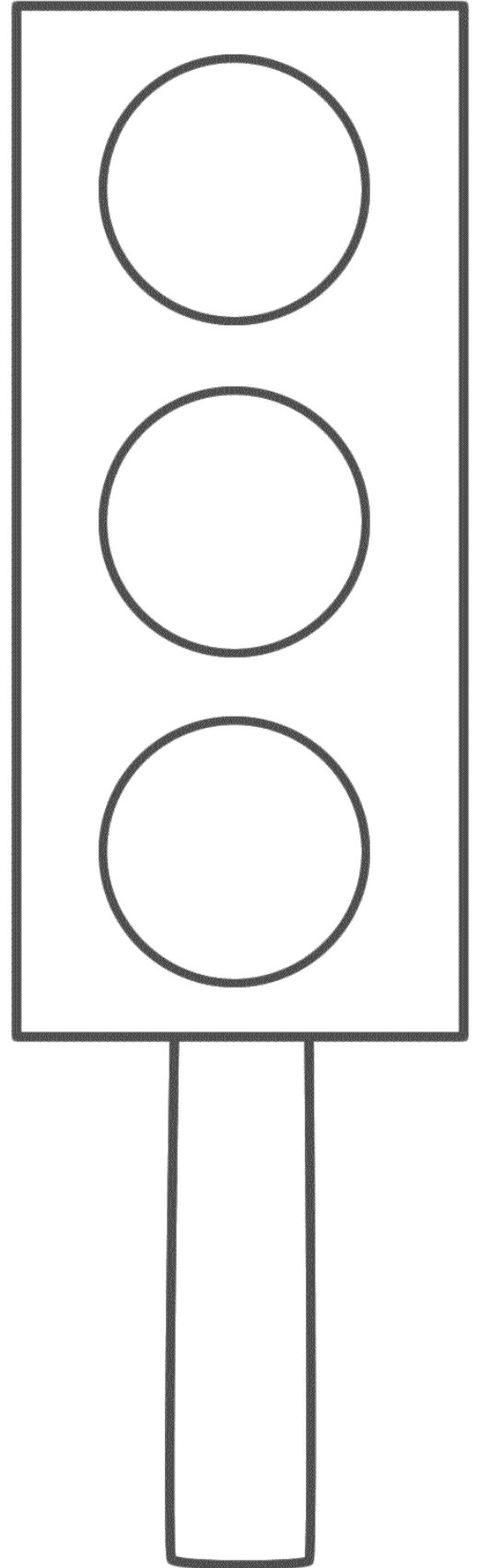

" سريع ، بطيء " أحوط الوسيلة الأسرع.

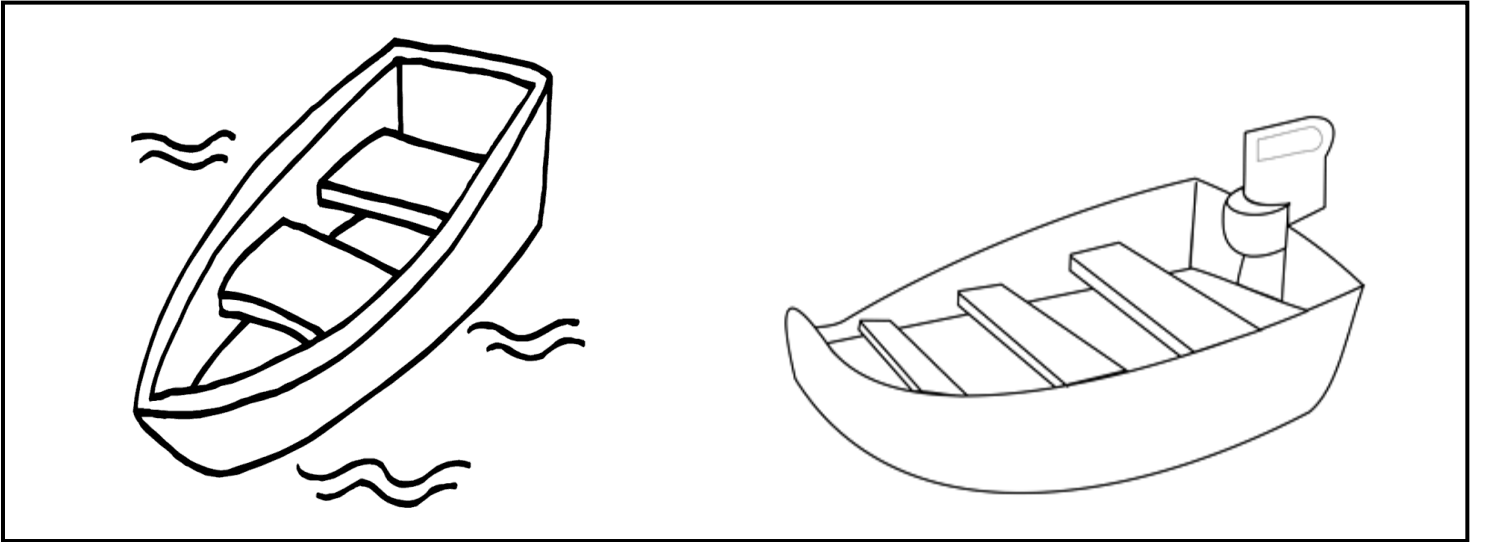
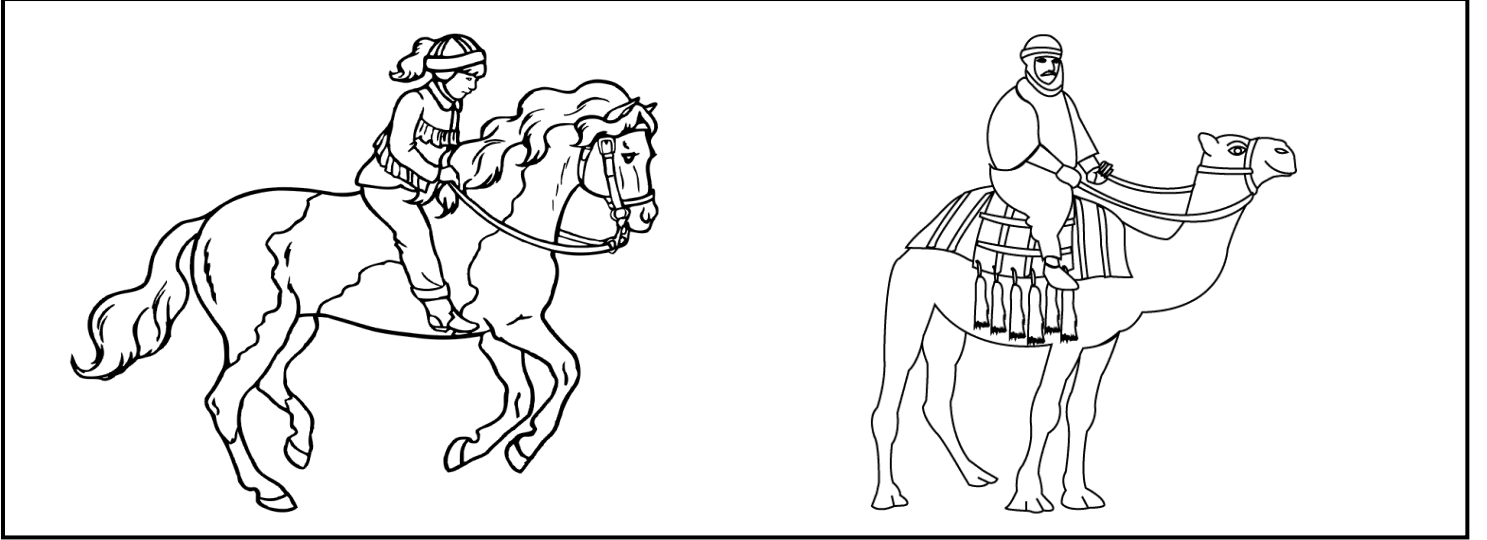
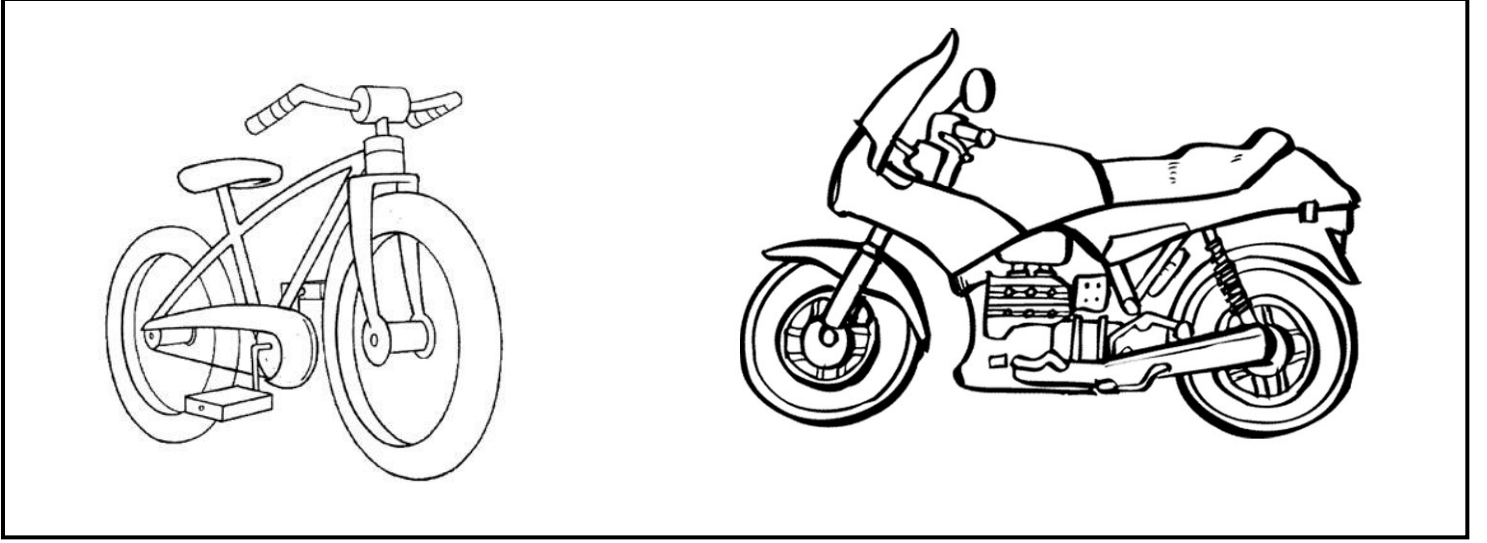

ألون سلوك سالم الصحيح في عبور الطريق.

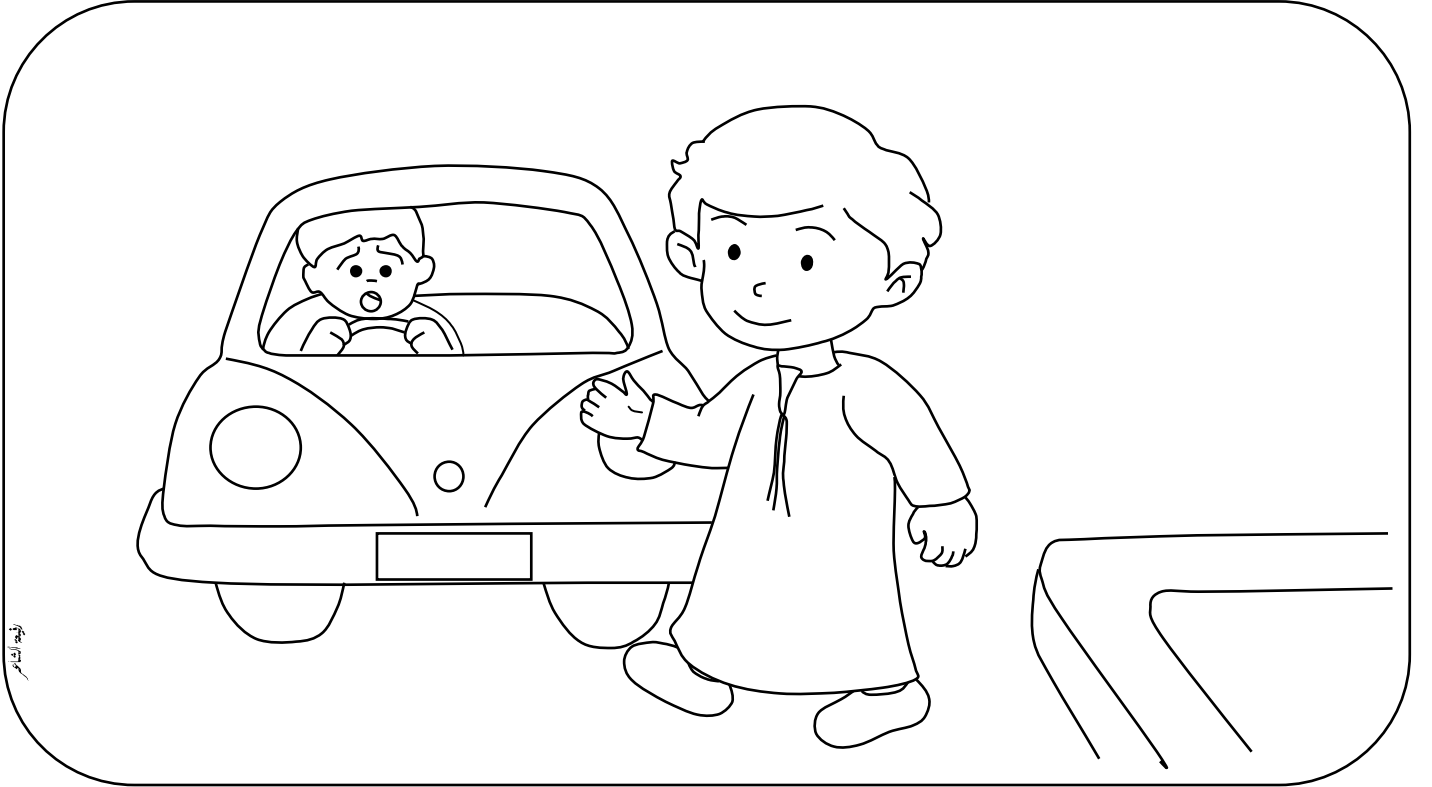
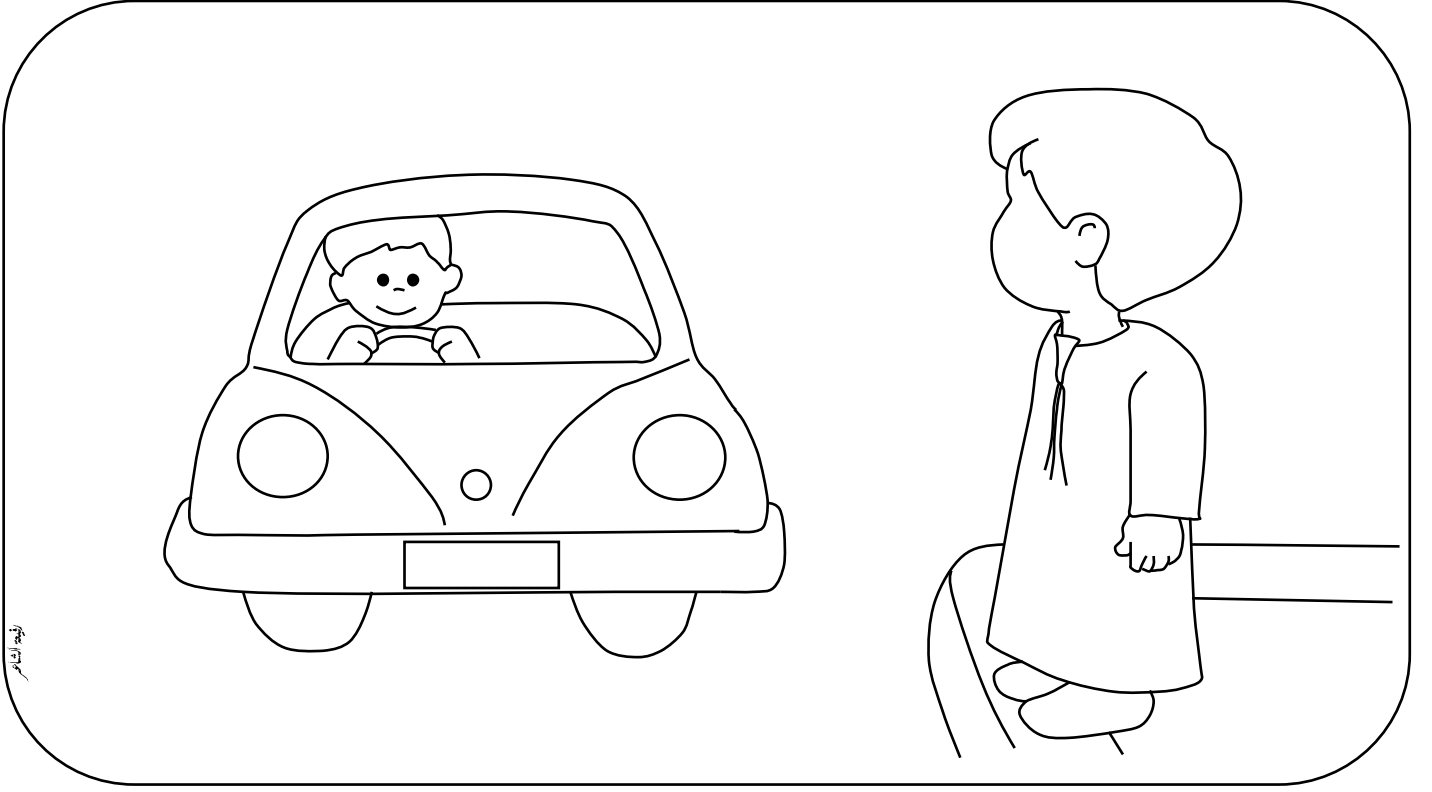

أبحث عن المستطيل وألونه.

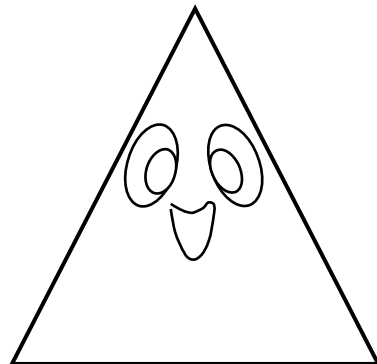
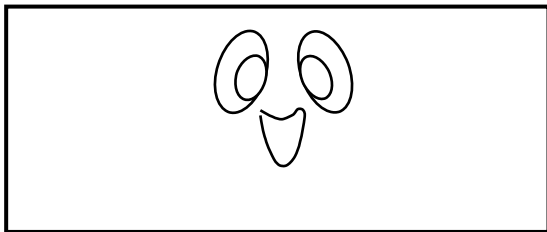
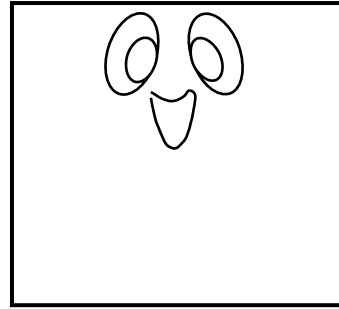
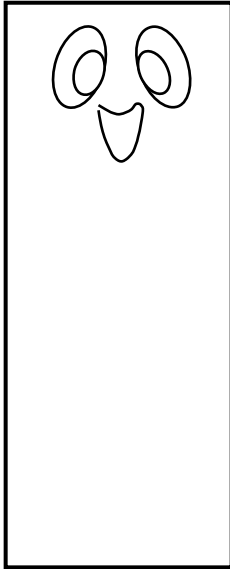
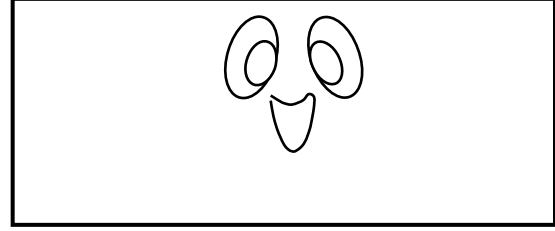
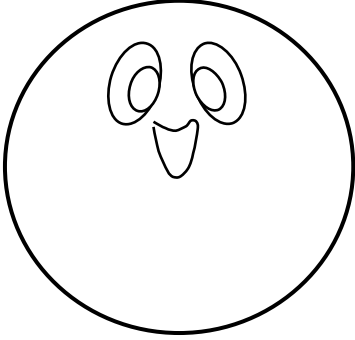



وحدة

السيرة النبوية



صلى الله
عليه
وسلم

أخطط على اسم نبينا محمد



محمد



صلى الله عليه وسلم



محمد



صلى الله عليه وسلم

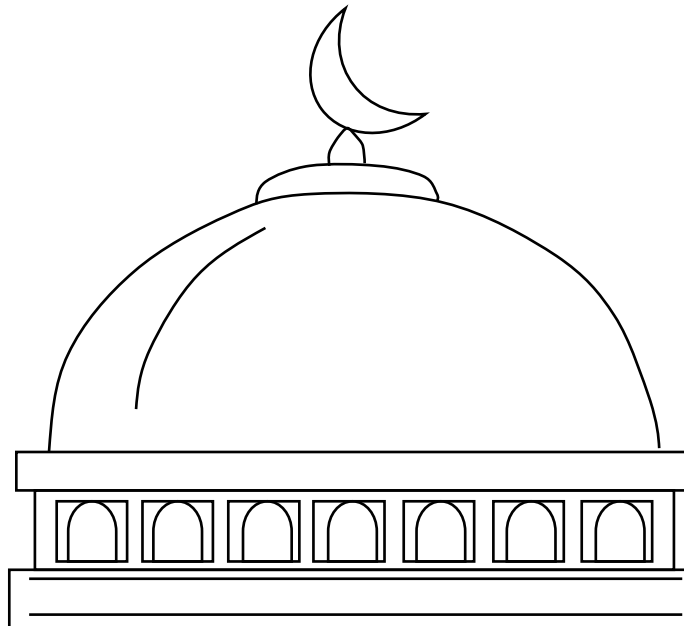

أطابق وأصل.

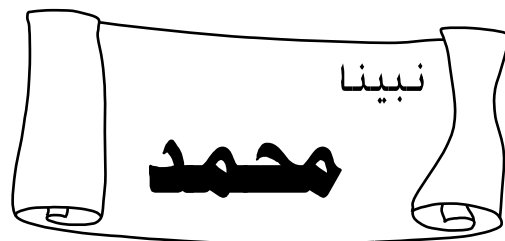
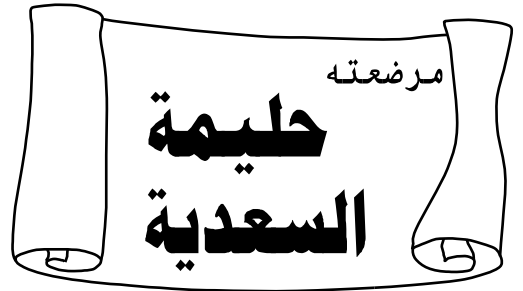
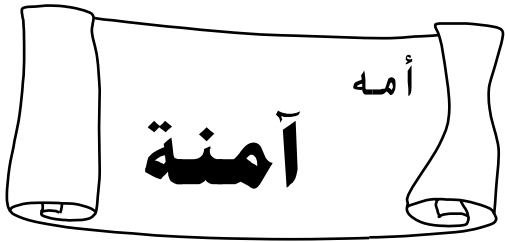
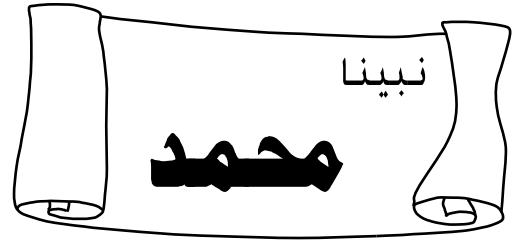
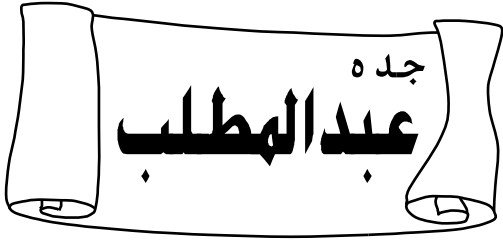
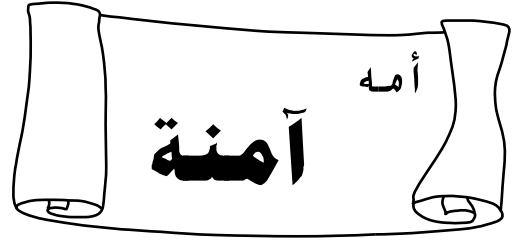

أبناء الرسول ﷺ ، أصل وأتعلم.

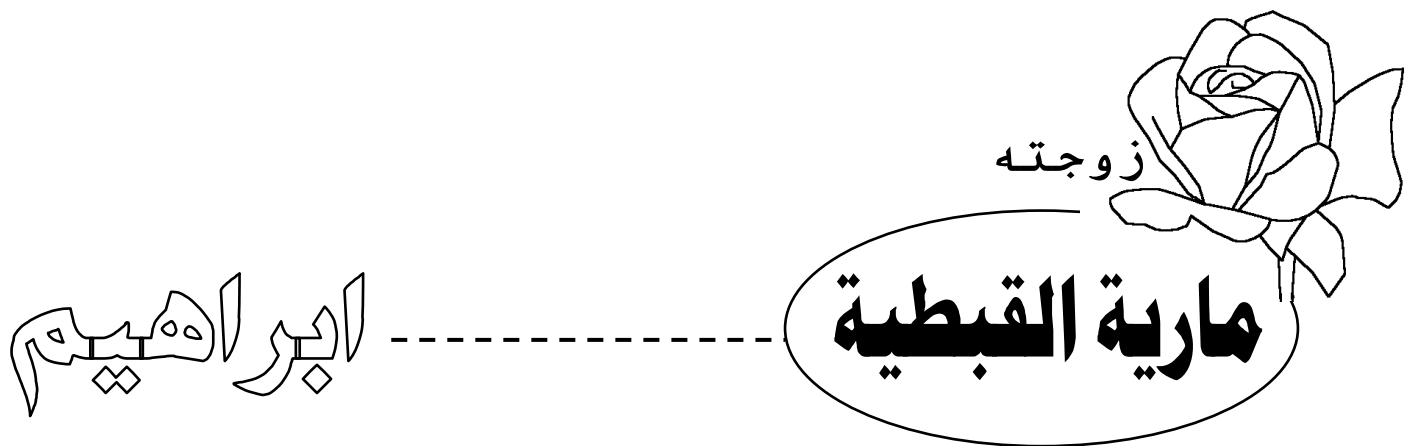
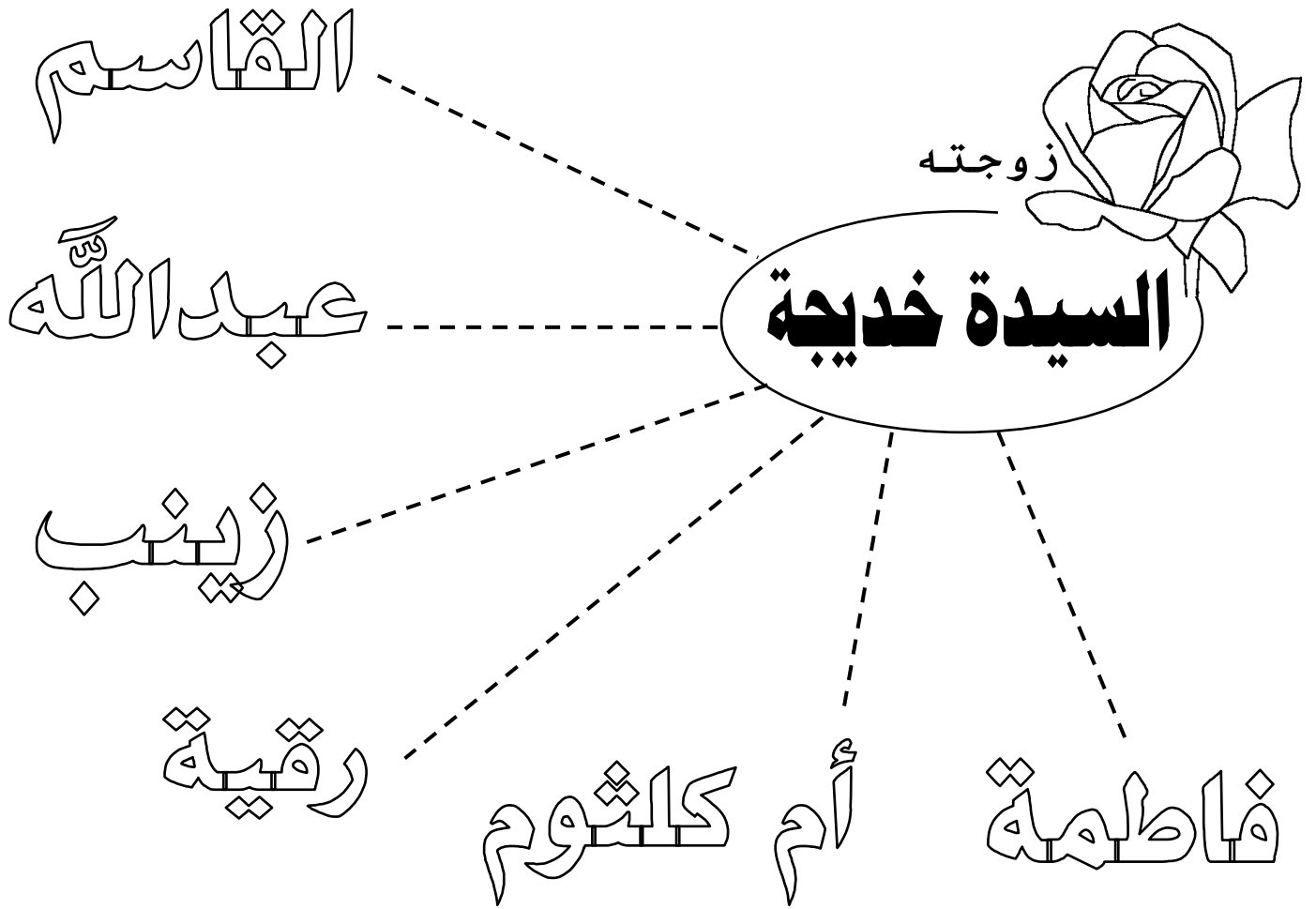

الدعوة إلى عبادة الله تعالى. اقرأ وألّون.

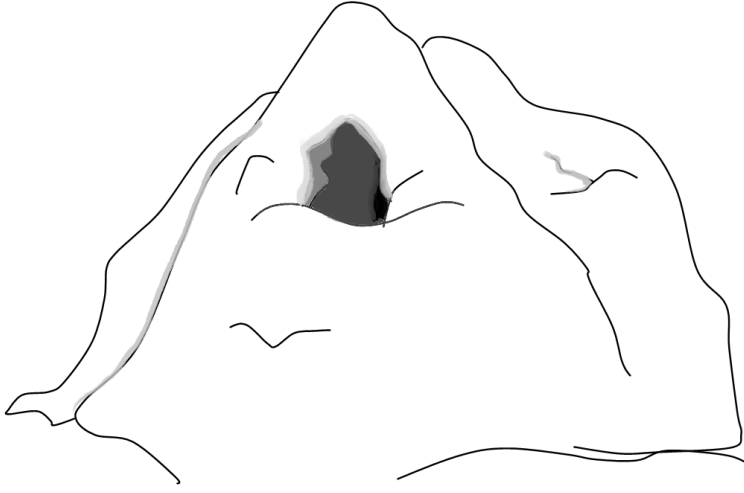

كان رسول الله
صلى الله
عليه
وسلم
يتعبد في

غار حراء

دعا الرسول صلى الله
عليه
وسلم
الناس إلى عبادة

الله تعالى
وترك عبادة الأصنام.



أقرأ وألّون.

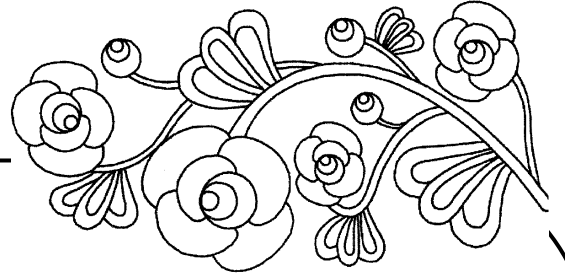

لا إله إلا الله

محمد رسول الله

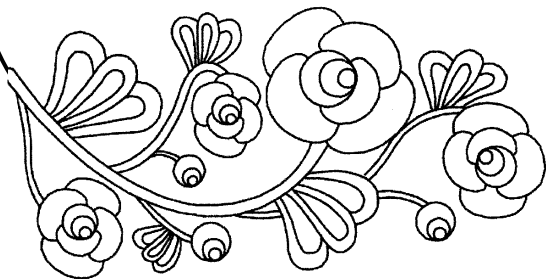

وحدة

السياحة



معالم بلادي كثيرة. أبحث عن معالم بلادي وأحوطها.

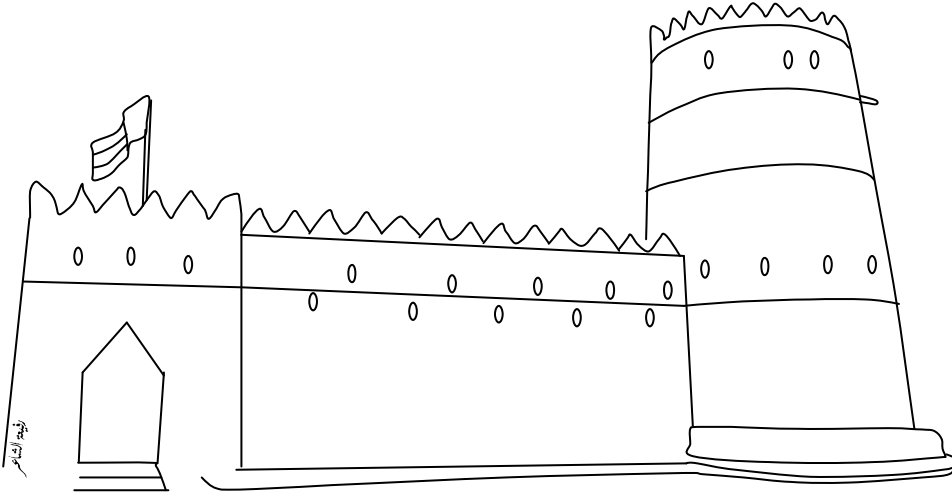
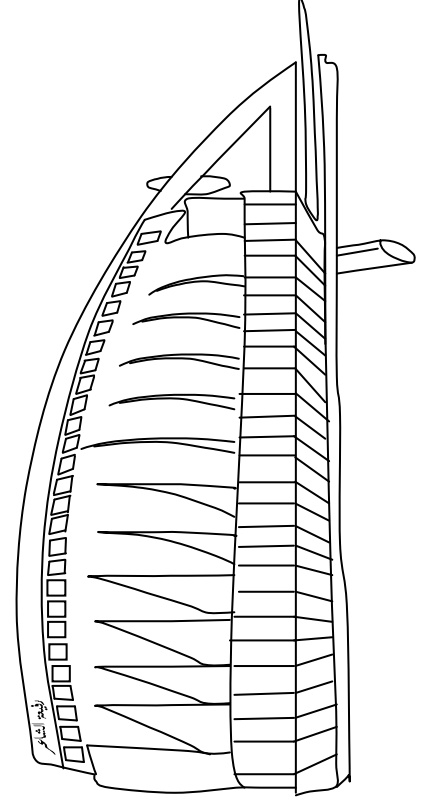
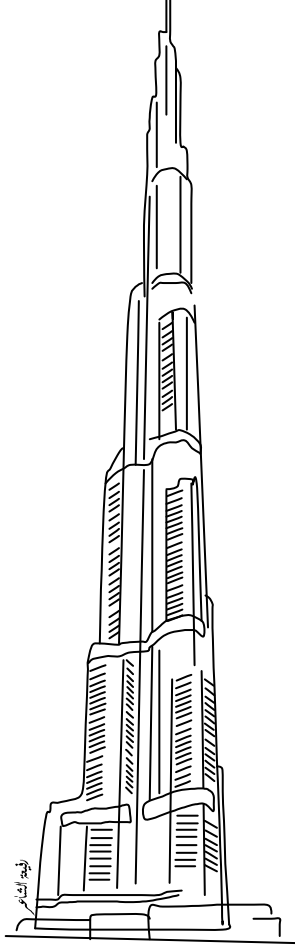

اختلاف العملات، أبحث عن ورقة نقدية لدولة الإمارات العربية المتحدة.



ماذا أحمل معي عند السفر؟ أحوط إجابتي

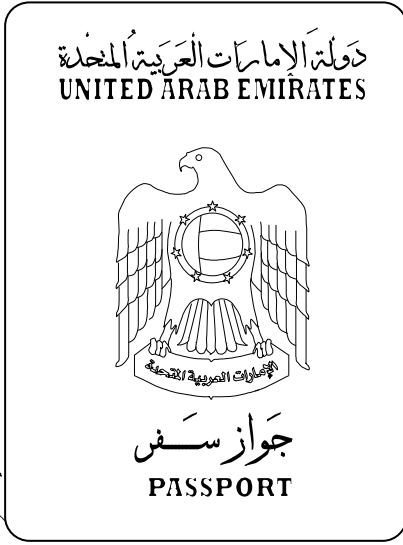

جواز سفر

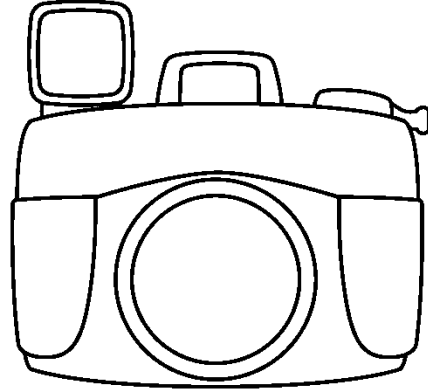

آلة تصوير

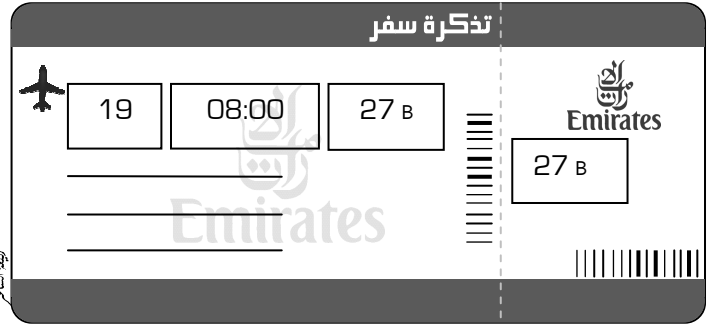

تذكرة سفر

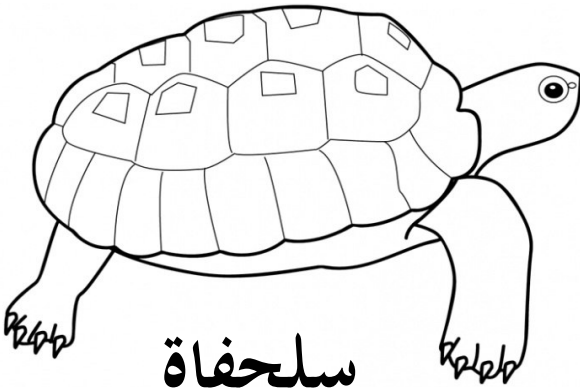

سلحفاة



أزهار

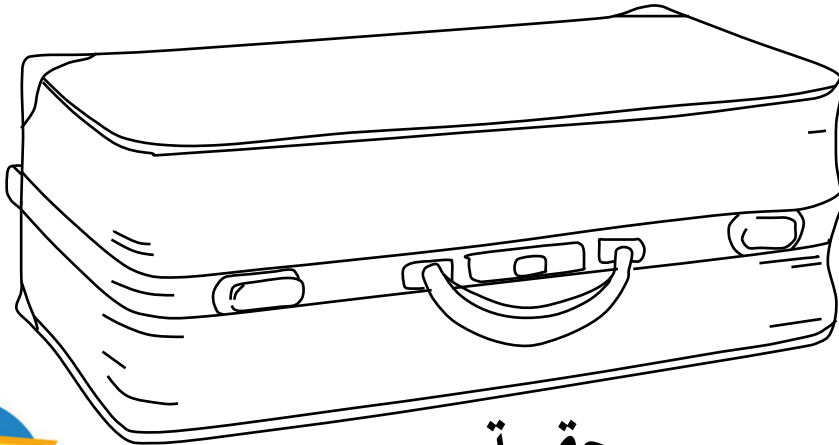

حقية



"جواز السفر" ألون جواز سفري ، أكتب اسمي ، ألصق صورتي.

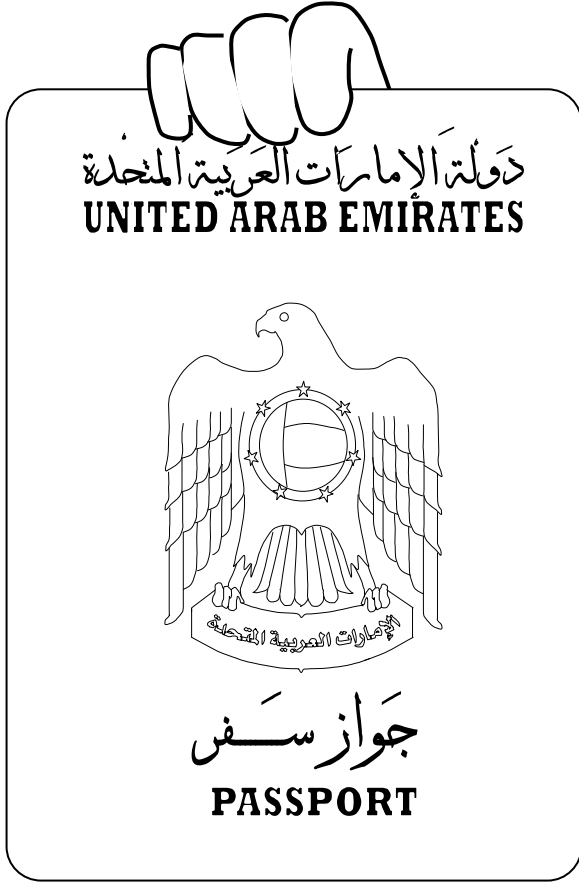

| | | | |
|----------------------|--|-------------------------------|--------------|
| UNITED ARAB EMIRATES | | دولة الإمارات العربية المتحدة | |
| جواز سفر PASSPORT | | رقم الجواز | |
| | | الاسم | |
| | | المهنة طالب | |
| | | تاريخ الميلاد | |
| | | الجنس | مكان الميلاد |
| | | تاريخ الإصدار | |





وحدة

الكتاب



للكتب موضوعات مختلفة، أصل الكتاب بغلافه.

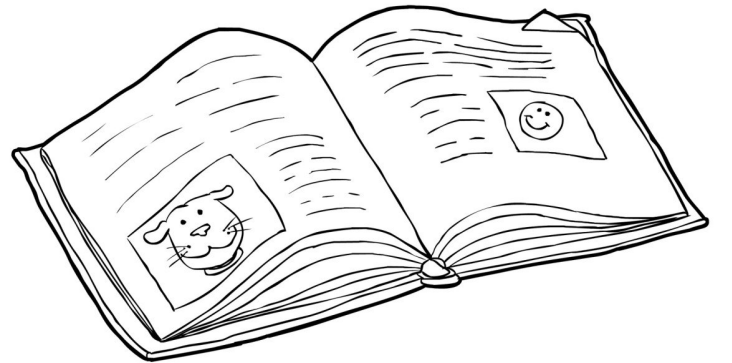
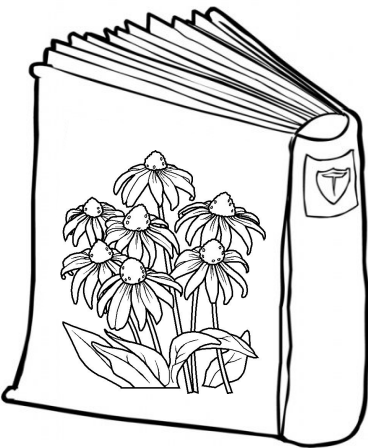
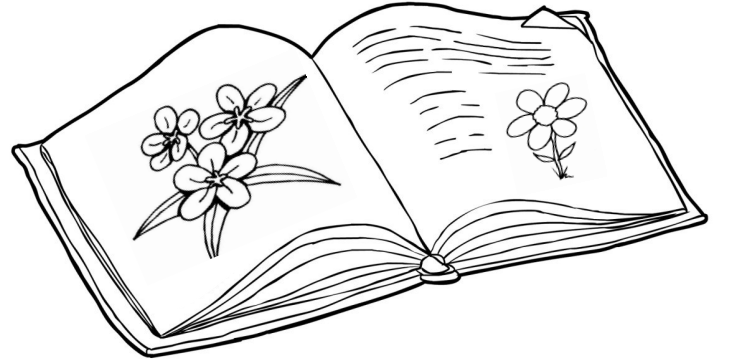

نقرأ أشياء كثيرة، أطابق وأصل.



أكتب رسالة لأمي.

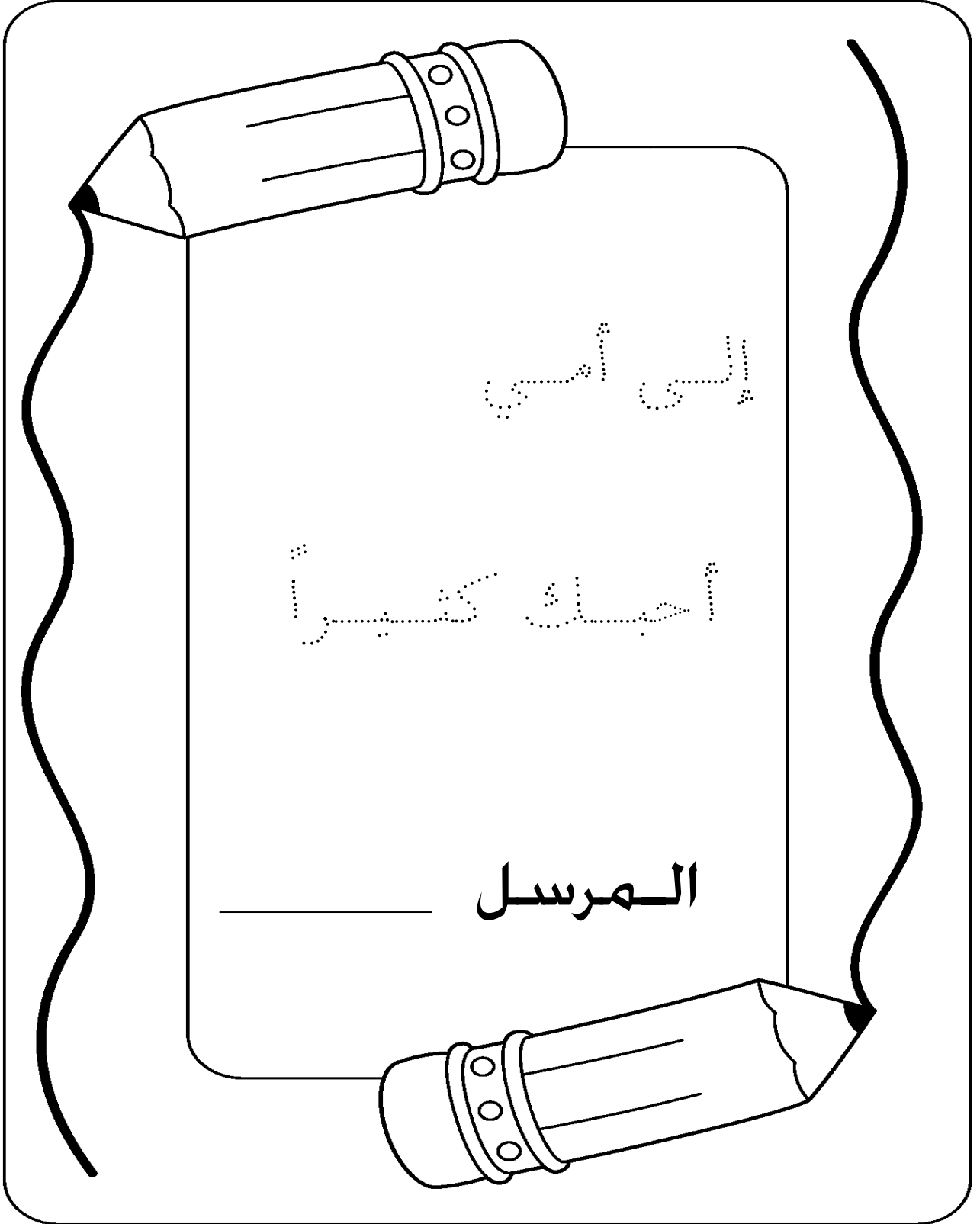

أحوط أدوات وأثاث غرفة المكتبة.

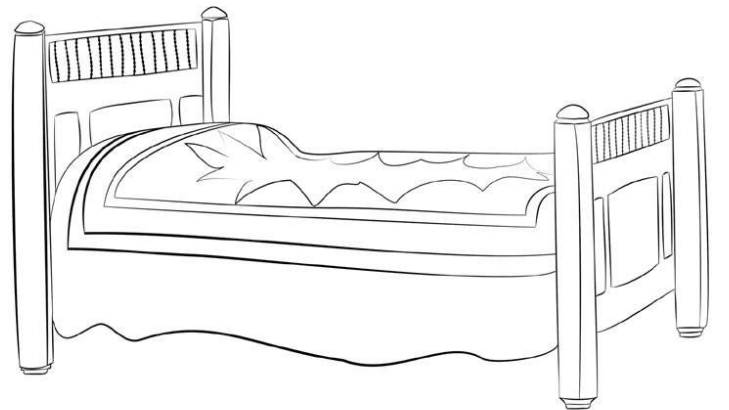
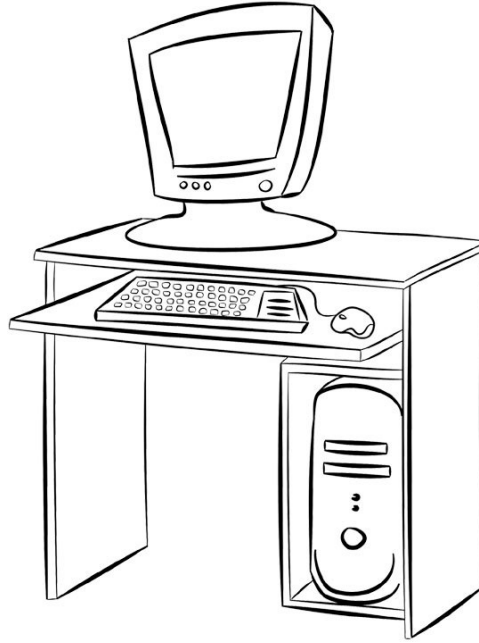
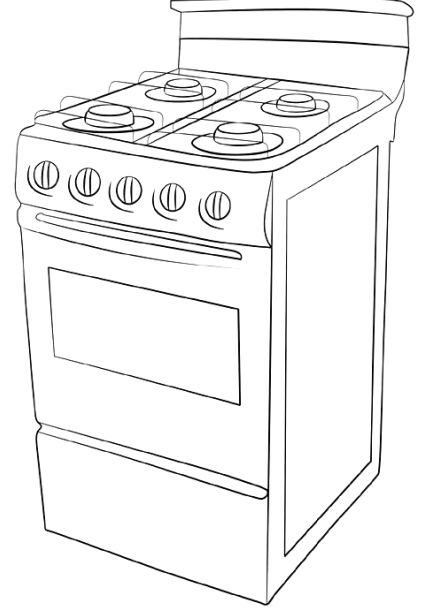

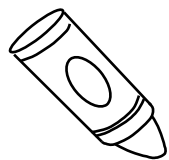

كتاب





وحدة

البيئة



البيئة كل ما يحيط بنا، أخطط عناصر مفهوم البيئة.

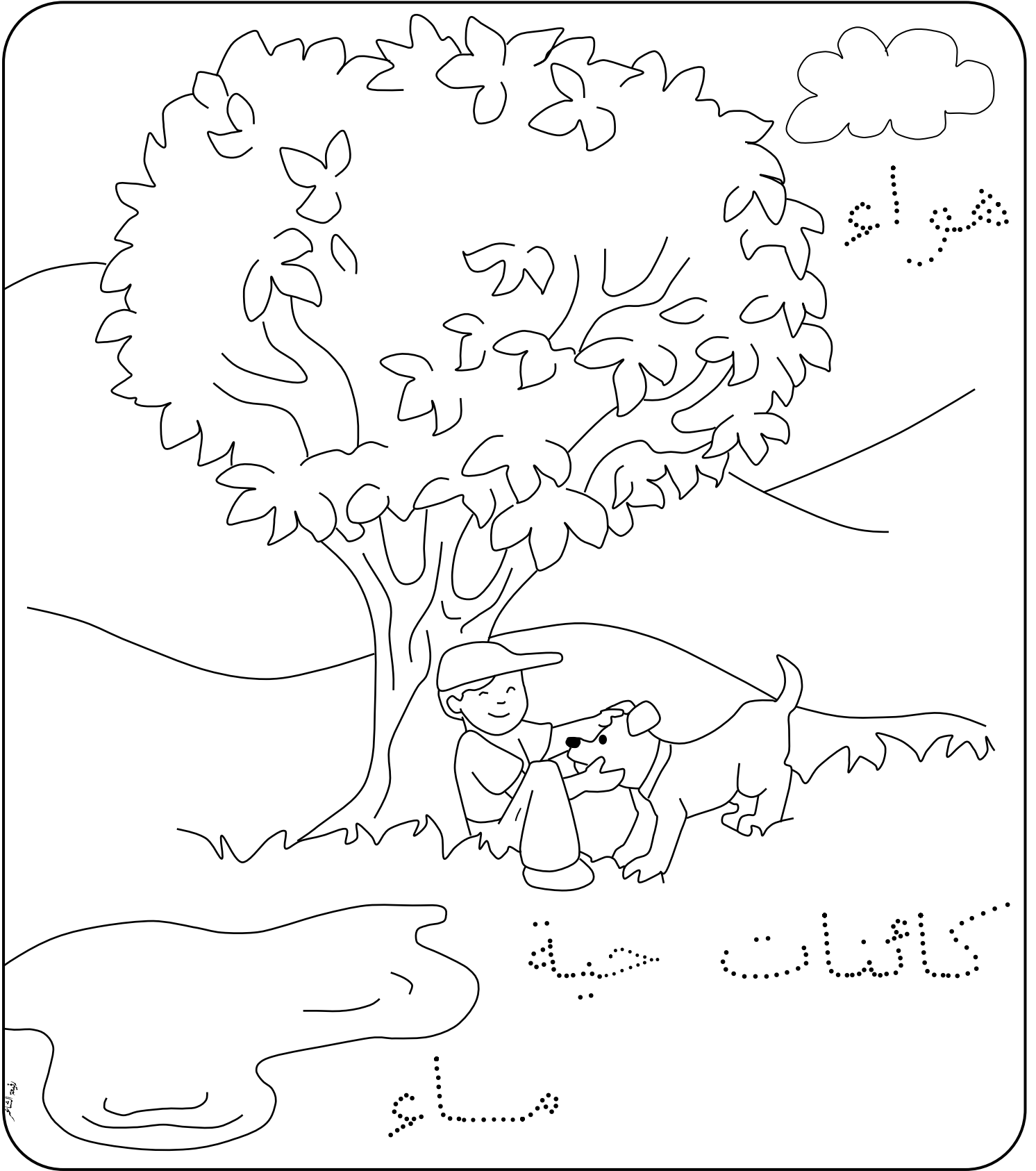

إعادة التدوير يحافظ على البيئة، أصل.

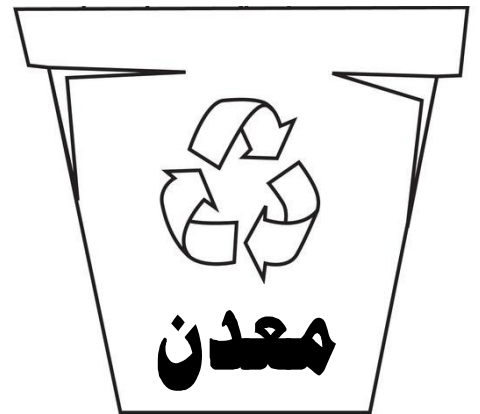
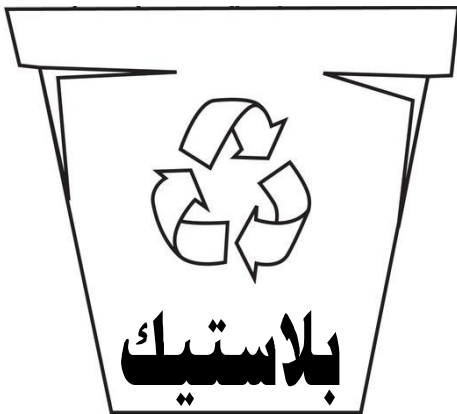
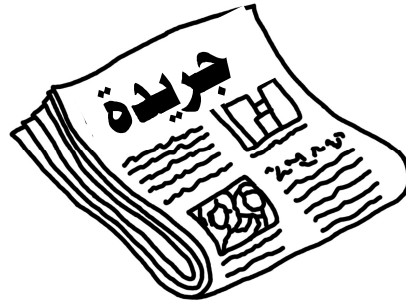
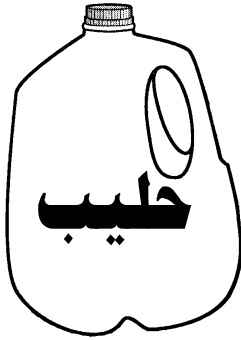
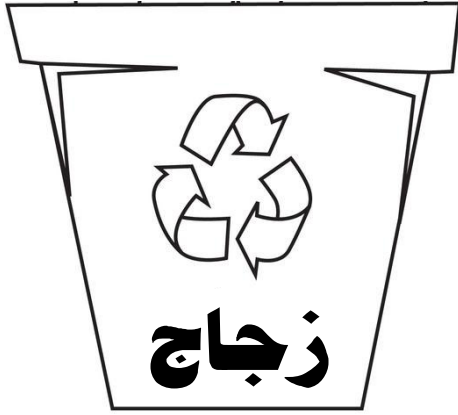

ألاحظ، استنتج، ألون.

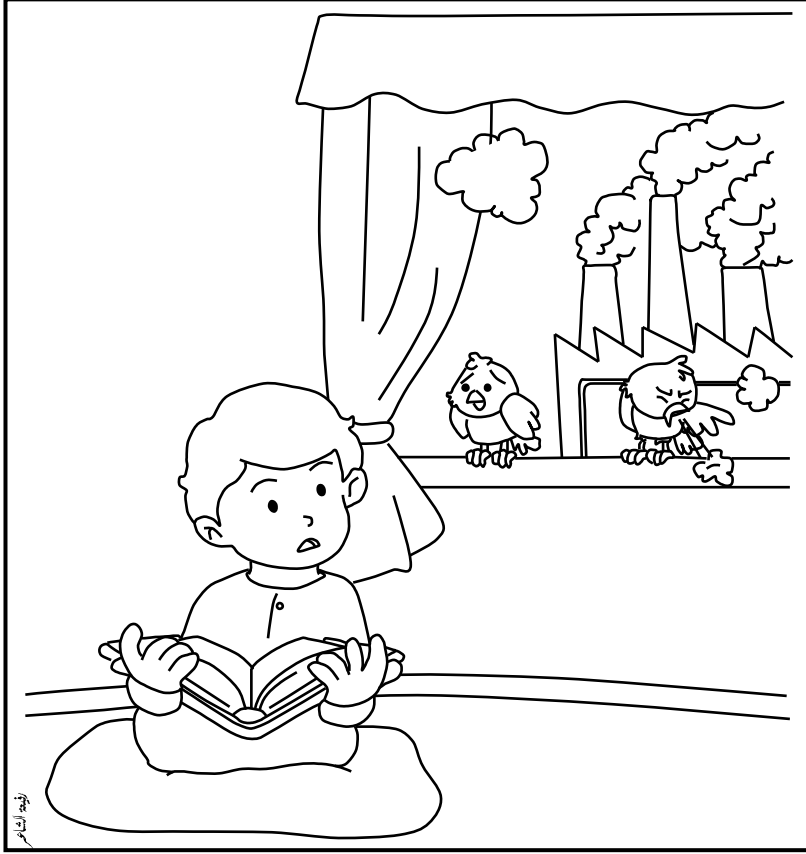

تلوث الهواء

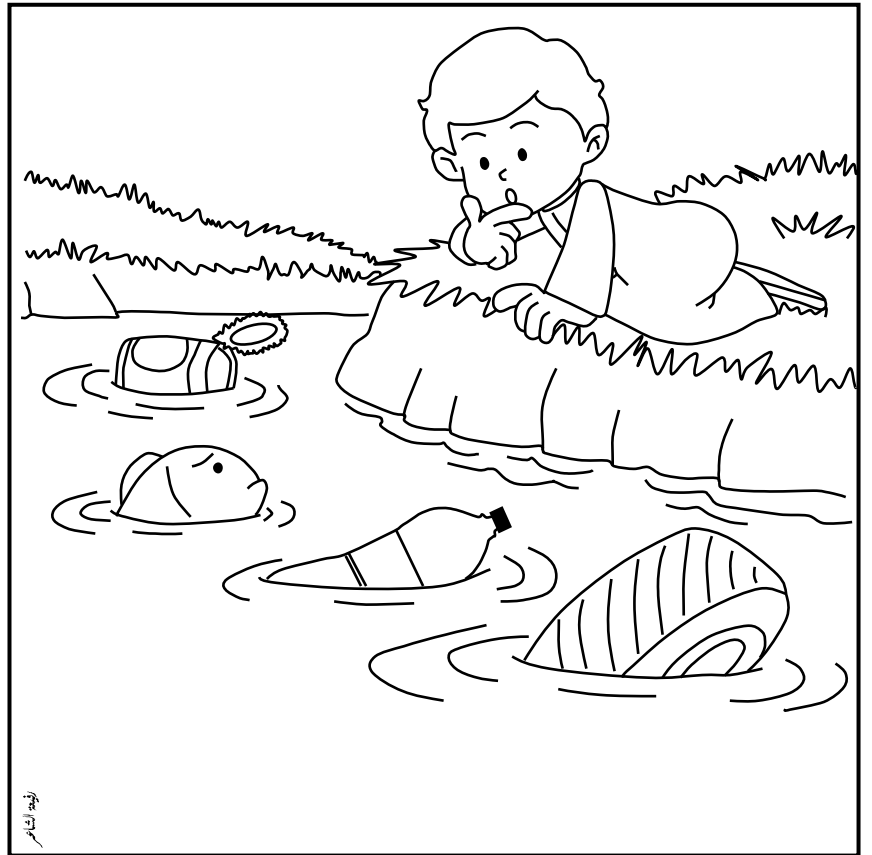

تلوث الماء

ما فائدة الهواء للكائنات الحية؟ ما هي أسباب تلوث الهواء؟ ماذا ينتج عن تلوث الهواء؟

ما فائدة الماء للكائنات الحية؟ ما هي أسباب تلوث الماء؟ ماذا ينتج عن تلوث الماء؟



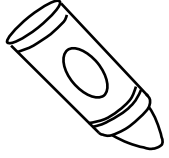

بيتي نظيفة .. عالمي نظيف





وحدة

الفضاء



ماذا يوجد في الفضاء؟ ألون.

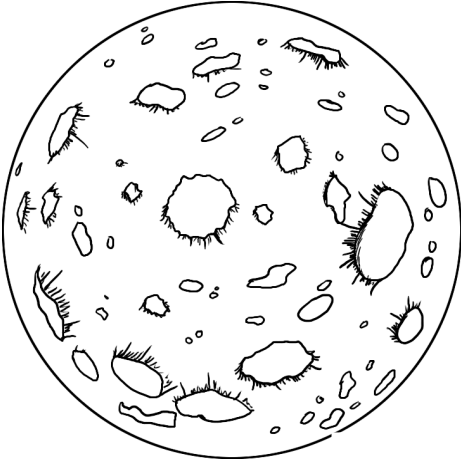

كوكب

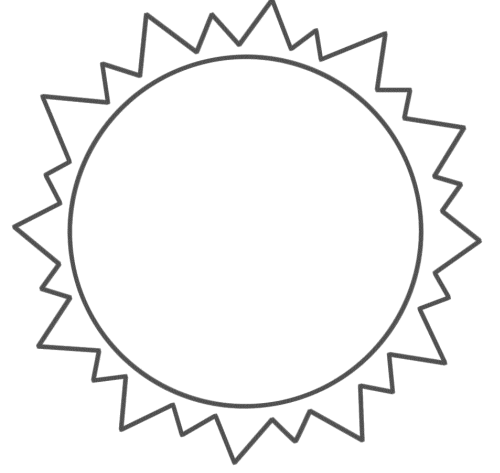

شمس

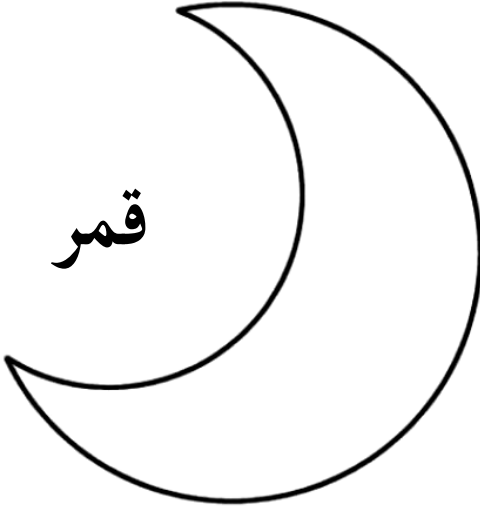

قمر

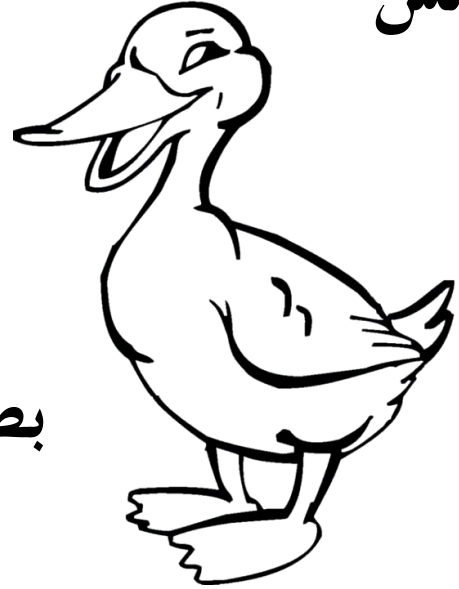

بطة

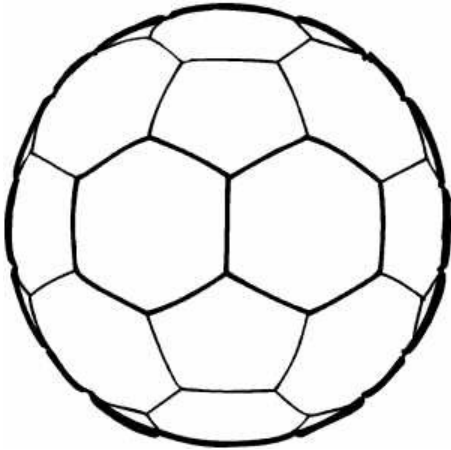

كرة



نجوم



الليل والنهار، أرسم ما أراه في السماء ليلاً ونهاراً.

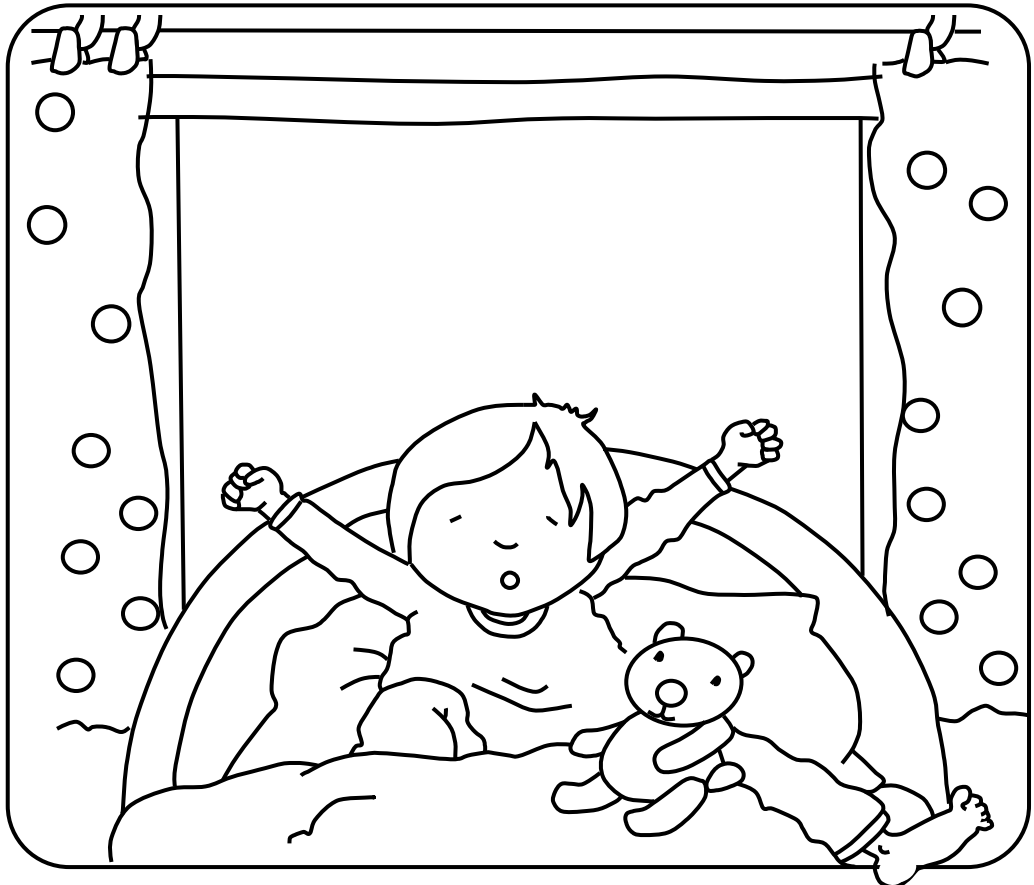
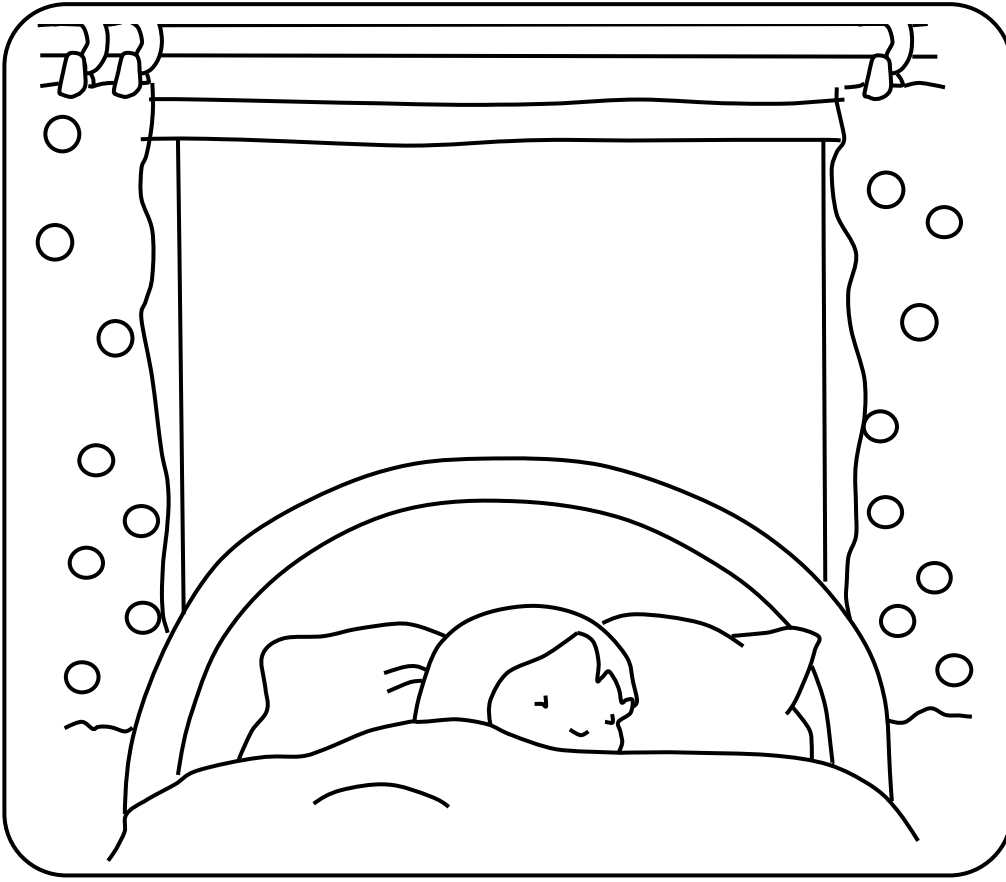

- الشمس والقمر، اختلاف الليل عن النهار ، قال تعالى " وجعلنا الليل سباتا . وجعلنا النهار معاشا"



نحن نعيش على كوكب الأرض.

أساعد المركبة الفضائية في العودة إلى كوكب الأرض، أصل.

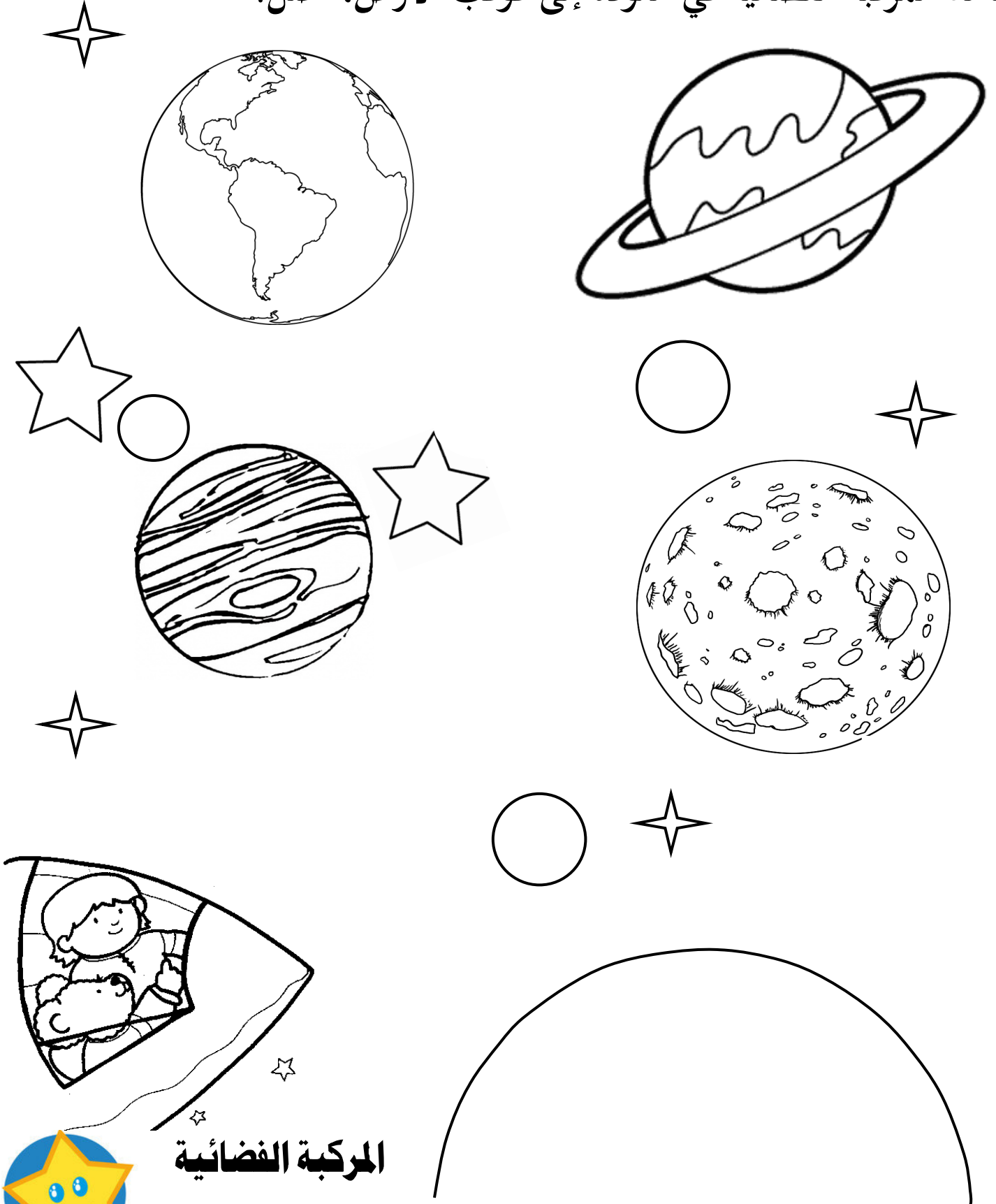

المركبة الفضائية

الفضاء

وحداتي



ماذا يلبس رائد الفضاء؟ أحوط إجابتي.

أنا رائد فضاء

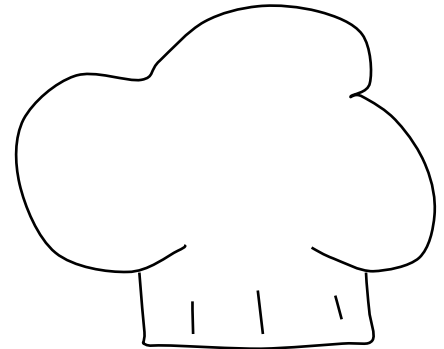
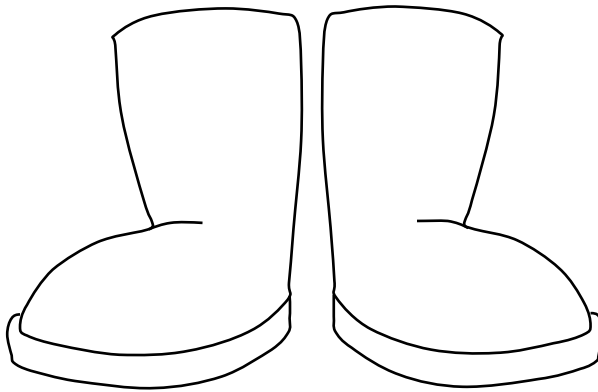
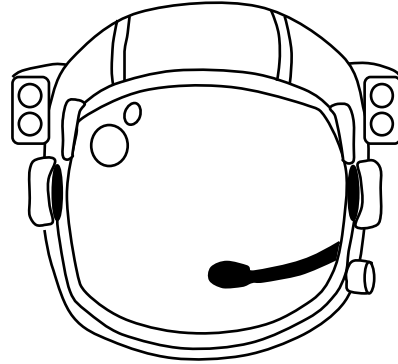
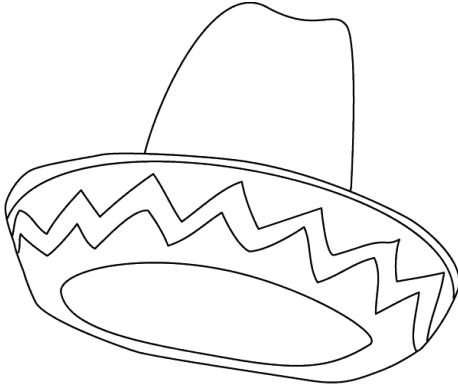
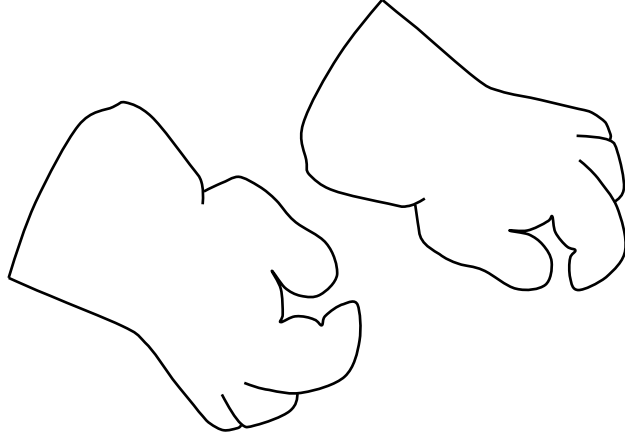

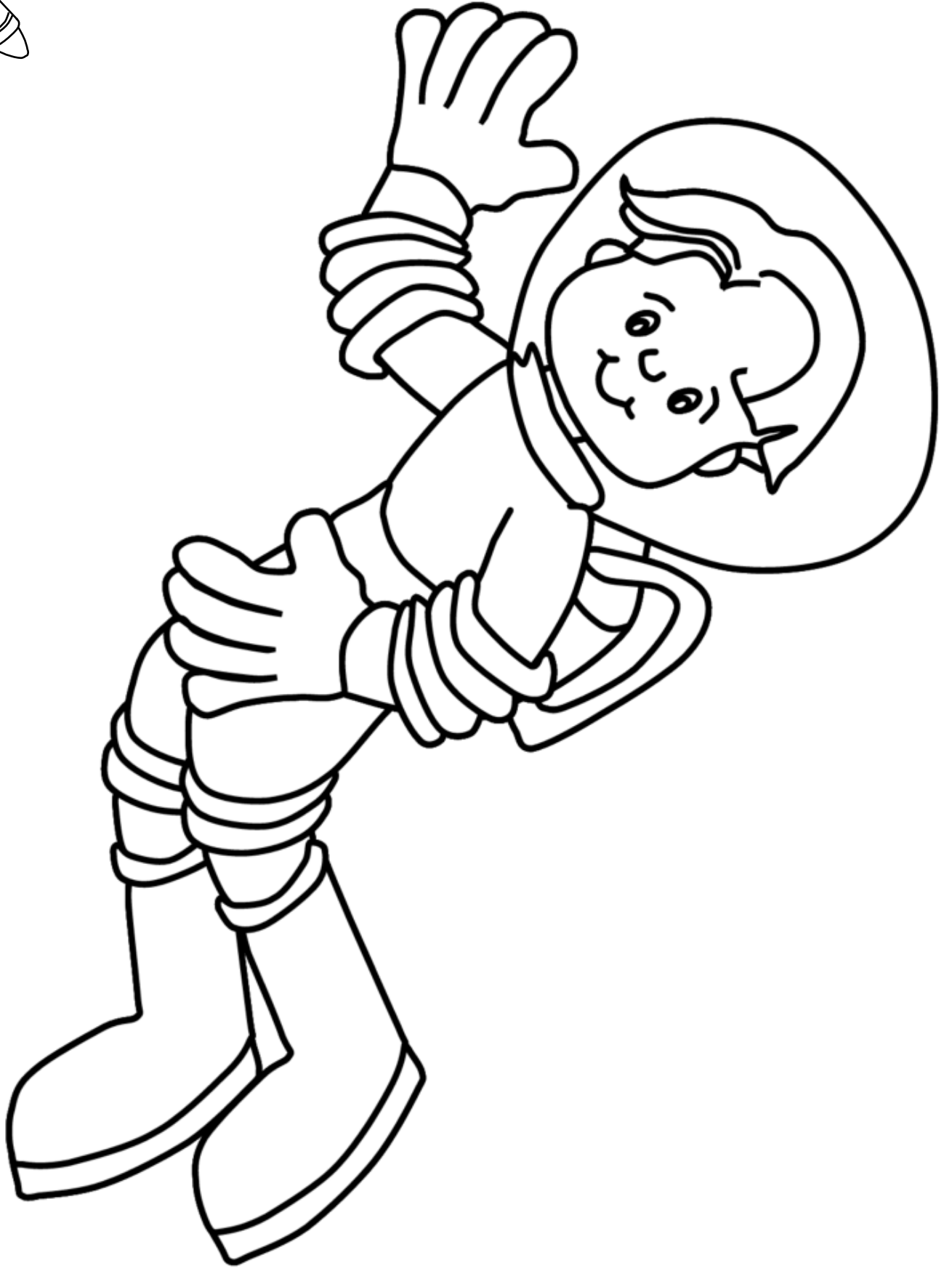
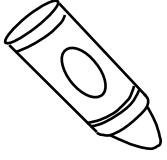

وحدة

مع السلامة



أرسم حفلة تخرجي.

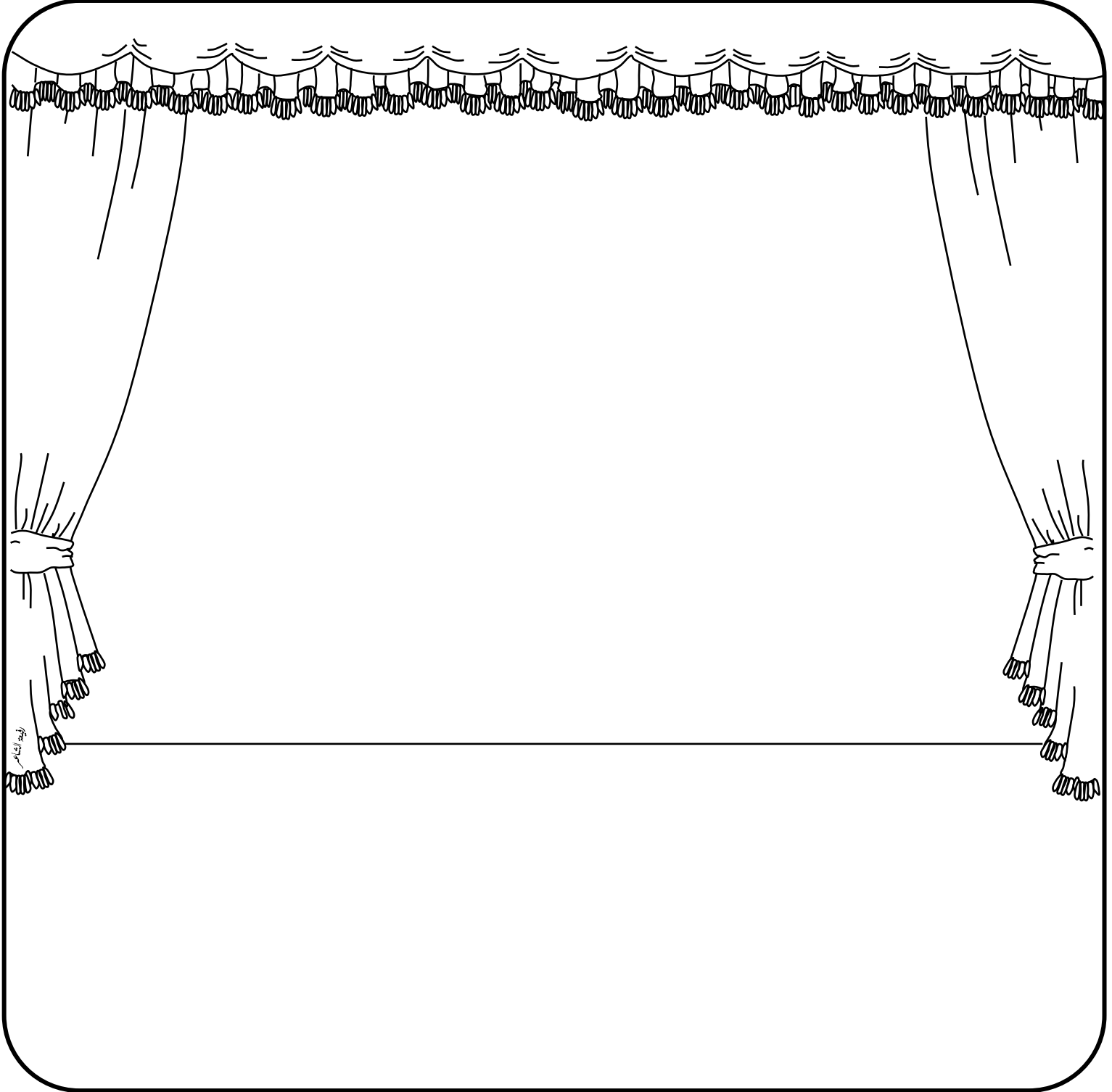

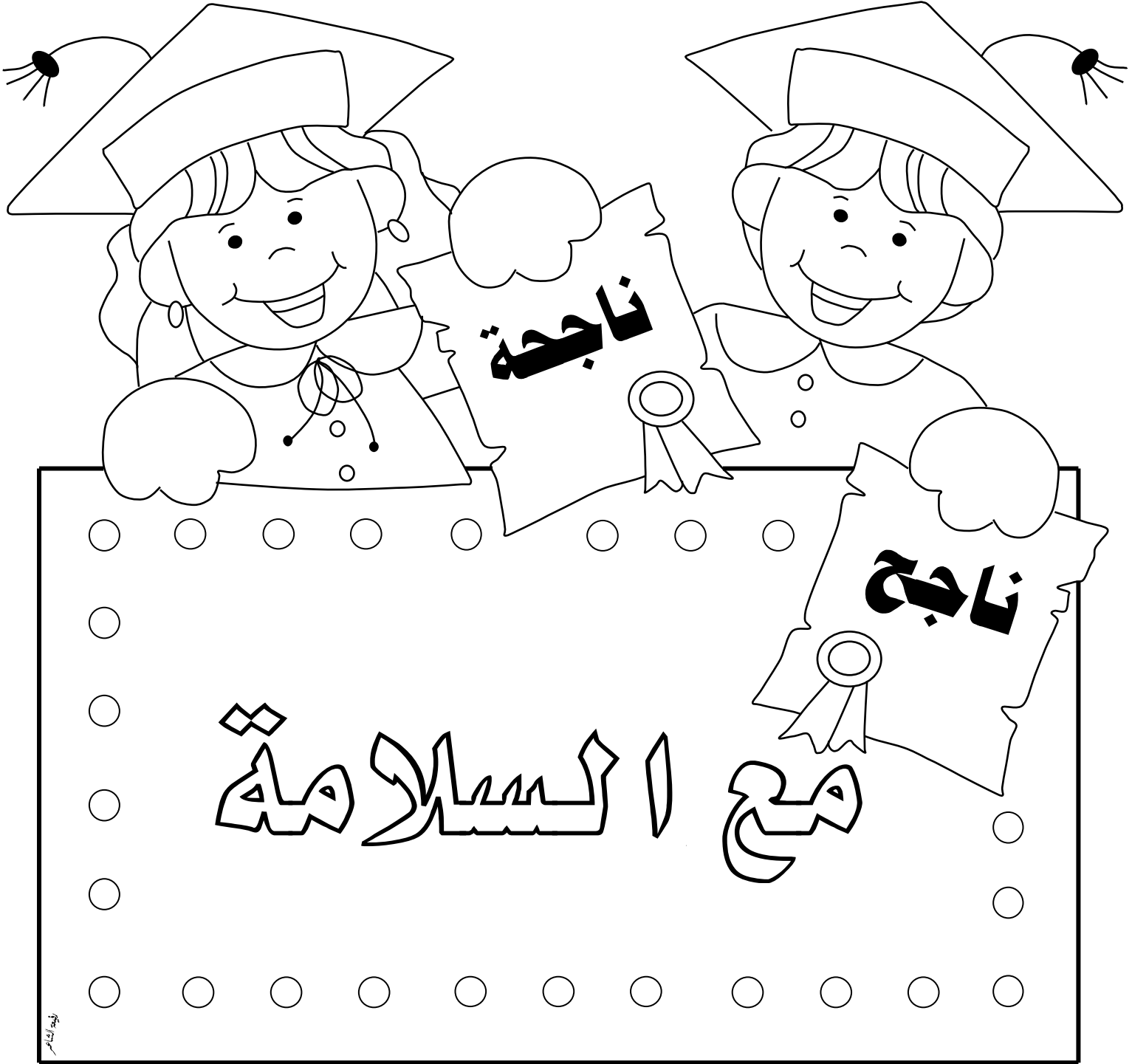
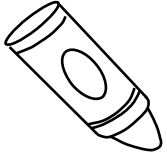



كتاب النشاط قص ولصق



كتاب وحداتي المستوى الثاني



كتاب وحداتي المستوى الأول

الكتب غير مخصصة للبيع

نشر على الموقع الإلكتروني

www.e-portal.ae البوابة التعليمية

لتحميل بقية الكتب ولمشاهدة المواضيع الأخرى المرتبطة
بوحدات رياض الأطفال، ندعوك لزيارة البوابة التعليمية

البوابة التعليمية

WWW.E-PORTAL.AE

